

more@**TURCK**

Turbocharger for IIoT

Managed high-speed switch in IP67 offers maximum data throughput, superfast link-up times and secure industrial Ethernet networks



Compact & Precise

With 35 percent less depth the IMXK isolation barriers and analog signal isolators also fit in small switch boxes

Convenient Controls

Velco monitors the parameters of its special machines with a remote maintenance solution based on Turck Cloud Solutions

Cool Heads

Asbreuk Service B.V. controls a loading system with the rugged TBEN-L-PLC IP67 block modules for refrigerated trucks – at -25 °C

»Smart Production Solutions«



On the occasion of its 30th anniversary, this year's SPS Fair in Nuremberg will be held under its new name of "Smart Production Solutions". The new claim is a stroke of genius, not only because it retains the three original letters by which the fair has become known, but also because it reflects the increasing digitalization of the automation sector. Information technology (IT) and operational technology (OT) are merging into one and thus creating new possibilities for smart automation solutions. This offers everyone involved enormous opportunities, as well as creating new tasks in need of a solution.

As your automation partner, Turck is tackling these tasks and offering you some innovative and efficient solutions for smart automation. A good example can be found in our fair pack: the only managed high-speed Ethernet switch with protection to IP67 in this design that meets all high speed requirements in modern automation networks directly in the field – without the need for

a control cabinet. To go with this we also offer X-coded Ethernet cables that are the first to enable 1 GBit/s communication in a seamless IP67 concept. We have also given some thought to the risks involved in the growth of networking and armed our switch with network security, so that you will always retain the sovereignty of your networks and any potential hackers won't have a chance in the first place. Find out more about these exciting topics on page 8.

Smart solutions with added value – that is the motivation behind our development work. As IP67 specialists we have offered an extensive portfolio of "cabinet-free" solutions for a long time – from the I/O module to the IO-Link master and controllers, right through to HMI's with controller functions. We offer automation and data – end-to-end from the sensor through to the cloud.

We can show at our fair stand how you can benefit from these concepts, which include for example condition monitoring. Experience live how with little effort you can make existing plants fit for the requirements of Industry 4.0 and thus secure your competitive edge. A foretaste on this can be found in this issue on page 14.

If we have caught your interest, experience the implementation of Smart Production Solutions in Nuremberg at stand 250 in Hall 7. Looking forward to meeting you.

Yours sincerely,

Olaf Ophoff, Director Business Unit Automation Systems

Content

NEWS

INNOVATIONS for Automation Specialists 04

COVER STORY

FIELDBUS TECHNOLOGY: Safe Turbocharger for IIoT 08

The TBEN-L-SE-M2 managed high-speed switch with protection to IP67 offers maximum data throughput, superfast link-up times and secure industrial Ethernet networks

INSIDE

INTERVIEW: »SIDI integrates IO-Link Devices in Profinet« 12

Turck's IO-Link masters enable the integration of IO-Link devices directly via SIDI (Simple IO-Link Device Integration) from Profinet Engineering. Frank Nolte, deputy editor-in-chief of the technical publication etz, talked about it with product marketing manager Sai Seidel-Sridhavan

TREND

CONDITION MONITORING: On the Pulse of the Machine 14

Existing plants can be made fit for condition monitoring in no time at all using smart sensors and flexible solutions for data transfer and visualization

TECHNOLOGY

INTERFACE TECHNOLOGY: Goodbye to the Door Stop 18

Turck's ultracompact IMXK isolation barriers and analog signal isolators have 35 percent less depth and also fit in compact switch boxes – ideal for module based process automation

SENSOR TECHNOLOGY: Generation Plus 20

Turck is putting its fluid portfolio on a standard technology platform and is presenting with the FS+ flow sensor the latest member of the series

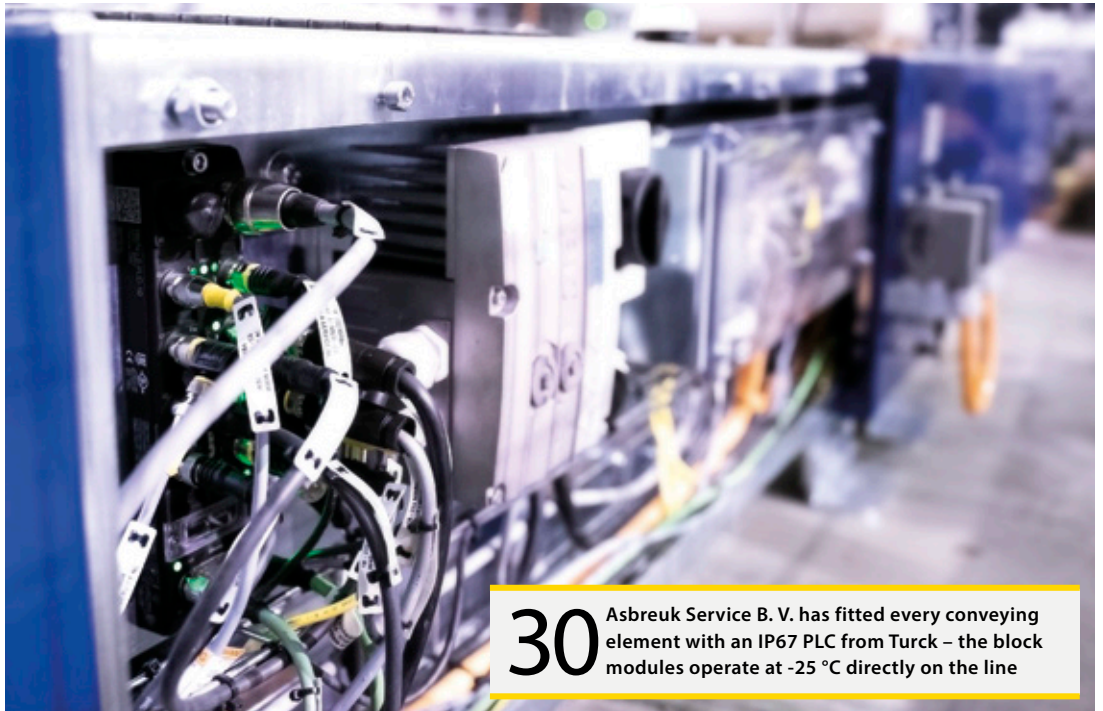

30 Asbreuk Service B. V. has fitted every conveying element with an IP67 PLC from Turck – the block modules operate at -25 °C directly on the line



22 Velco has worldwide access to its machines via Turck Cloud Solutions



20 Addition: Following on from the PS+ pressure sensor Turck now presents the FS+ flow sensor

APPLICATIONS

CLOUD SOLUTIONS: Taskforce for Rapid Intervention 22
 Special machine manufacturer Velco uses a remote monitoring solution based on Turck Cloud Solutions for locating error sources and monitoring production parameters

SAFETY: Modular – with Safety 26
 AWL-Techniek is a company offering scalable safety technology directly on the modules of its M-Line machine platform – implemented with Turck’s IP67 IO-Link and safety I/O concept

CONTROL TECHNOLOGY: Cool Heads 30
 Asbreuk Service B. V. equipped a fully automated and modular loading and unloading system for trucks – decentralized controlled by robust IP67 modules TBEN-L-PLC at -25 °C

SENSOR TECHNOLOGY: Double Agent 34
 In magnetic stirrers of AWH, a magnetic field sensor detects the speed and direction of the mixing head

SENSOR TECHNOLOGY: Sticking Everything 38
 Dispensers of the Chinese manufacturer Anda Automation distribute soft solder and adhesive at high-speed and require for capacitive sensors level monitoring that are particularly compact – such as Turck’s BC10-QF5.5

SENSOR TECHNOLOGY: Heavy Metal 40
 When you need to drill a hole through the Gotthard pass or save the Leaning Tower of Pisa, Rollstar’s heavy duty planetary gearboxes are the right tools for the job – fitted with inductive sensors from Turck for the reliable monitoring of speed and switch positions

SERVICE

CONTACT: Your Fast Route to Turck 42
 How, where and when to find us

CONTACT: Imprint 43

Turnover of 640 Million Euros Expected



In spite of the difficult economic climate in its core markets of machine building and the automobile industry, Turck expects a consolidated total turnover of 640 million euros that is virtually the same as that of the previous year. Compared to the 660 million euros of 2018, this represents a slight decrease of around three percent. "Having achieved outstanding two-digit growth for Turck in the last two years, we will not be able to fully reach the targets we set in 2019," says Turck managing director Christian Wolf. "In spite of the generally unfavorable business environment for factory automation, we were nevertheless able to avoid any severe losses and expect to achieve almost the same result as last year." The number of employees at all Turck sites worldwide is almost unchanged at 4650.

Sustainable Packaging Concept

Turck is reducing the use of plastic down to a minimum at its Mülheim Logistics Center, thanks to the use of a new sustainable packaging concept. The ergonomic packaging technology with new cardboard packaging at the same time reduces the physical load placed on employees. From a total of five cardboard box types, employees are able to select the optimum packaging for the majority of shipments and thus eliminate the need for filling material. The plastic bubble wrap and cushions previously used as a filling material have been fully replaced by Green Line paper packaging, which is made 100 percent from recycling material. The PVC adhesive tape is also no longer used – large cardboard boxes are closed with wet adhesive tape.

Managed Ethernet Switch with IP67



read more
on page 8

Turck is presenting at this year's SPS fair a compact 10-port managed switch with IP67 protection. Thanks to its very high data rates up to 1Gbit/s, the robust TBEN-L-SE-M2 makes it possible to considerably speed up applications, such as for tool changing. Thanks to its suitability for decentralized installation directly in the field, the switch also reduces the wiring required between the control cabinet and Ethernet stations on the machine. The TBEN-L switch thus clears the way for consistent modularization in machine building. The switch offers several functions for the secure organization of Ethernet networks.

LabVIEW Drivers for IP67 Block I/O Modules

The website of National Instruments now offers downloadable LabVIEW drivers for Turck's compact TBEN-S I/O modules. The new drivers enable users to significantly reduce the costs for the automation of test stands in production. The robust TBEN-S2-2RFID-4DXP, TBEN-S2-4AO, TBEN-S2-4AI and TBEN-S1-8DXP I/O block modules can replace the expensive I/O systems that are commonly used for test stand automation. A separate PLC for controlling the modules is no longer needed. Thanks to their high IP67 protection, the modules can be installed directly in the field without the need for a control cabinet. The LabVIEW drivers were developed in close cooperation with Turck as part of a customer project by specialists at Kirschenhofer Maschinen GmbH.



Compact Flow Sensor with IO-Link

Turck is presenting its FS+ flow sensor – another product from its fluid sensor series. The robust sensor comes with a highly robust stainless steel housing, together with a one-piece translucent front cap and is operated like a smartphone via a wear-free touchpad. In addition to flow, the FS+ can continuously measure the temperature of the medium. How the probe is aligned in the pipe is not important here. The bicolor 11-segment LED strip enables either flow or temperature values to be displayed as required. For rapid commissioning, the FS+ makes it possible to detect PNP/NPN signals automatically. Users can also set a switch point in just a few seconds using the Quick-Teach function. Read more on page 20



Compact Interface Devices

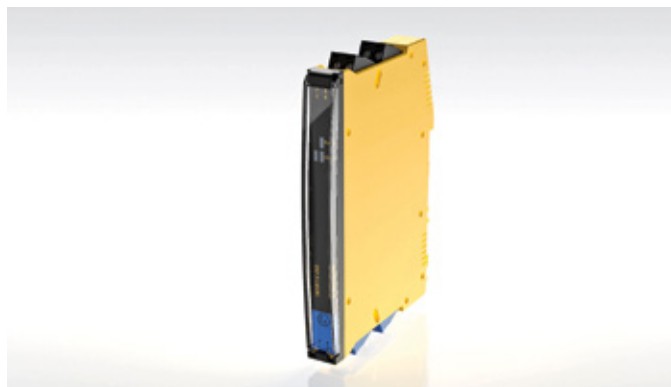

read more
on page 18

Turck is expanding its interface portfolio with the compact single-channel IMXX series for control cabinets with shallow casings, which are commonly used in modular machines or mobile applications. With a depth of only 77 mm, the IMXX series is 35 percent shorter than the latest conventional interface devices. In terms of precision and speed in real conditions, the IMXX outperforms comparable device types with larger dimensions. The IMXX devices can be used as associated equipment for the connection of intrinsically safe field devices through to Zone 0.

Turck Acquires Stake in Asinco



The Turck Group has acquired a minority interest in Asinco, the Duisburg-based specialist for radar measurement technology and industrial automation. In this way, Turck is not only securing its R&D competence in radar measurement sensors, but also its know-how in the area of software, which is particularly relevant for future projects in the field of smart sensors. Besides the flexible development resources, Turck will benefit from the in-depth knowledge of Asinco employees in closed-loop and open-loop technology, artificial intelligence and firmware. Asinco will in turn benefit from Turck's hardware and sector know-how, as well as its global production, marketing and sales network.

Ethernet Gateway for Remote I/O excom

The new GEN-N Ethernet multiprotocol gateway makes the excom remote I/O system fit for Industrial Ethernet networks. The gateway makes it possible to integrate the excom system in higher-level Ethernet networks with the Profinet, Ethernet/IP and Modbus TCP protocols. The connection is implemented via standard RJ45 connectors with at least CAT5e cable quality. The integrated switch enables a ring topology to be implemented in accordance with DLR or MRP, which considerably increases the availability of the overall system. The gateway supports 10/100 MBit/s, half/full duplex transmission, auto negotiation and auto crossing.



New Managing Director for Production



Michael Gröbner will become the new managing director of Werner Turck GmbH & Co. KG and the Turck Holding GmbH from December 1, 2019. At the same time, the 44-year-old will also take over the management of the Production and Development area in the Turck Holding GmbH. Gröbner has many years of experience in production and management in international companies, most recently as managing director of Norgren GmbH. As part of his training he will be working closely with the holding company managing directors Christian Wolf (Sales & Marketing) and Christian Pauli (Finance, IT & HR), as well as the interim managing director Joachim Göddertz.

New Production Facility in Europe



Turck is optimizing its global supply chain structure with a new production facility in Europe. The additional production facility in Lublin in Eastern Poland will enable the automation specialists to meet the requirements of regional markets faster and more efficiently and reduce any inefficient logistics routes. Turck Automation Technology Sp z o.o. is a subsidiary of Werner Turck GmbH & Co. KG, which is responsible for development and production within the Turck Group. The new plant in Lublin adds to the six production facilities of the Turck Group so far in Halver, Beierfeld, in Switzerland, the USA, Mexico and China.

Optimized Encoder Portfolio



With an optimized encoder portfolio, Turck will serve in future a wide range of customer requirements – from price sensitive encoders, right through to particularly robust and wear free devices. From three product lines, users have the choice between conventional encoders of the Efficiency or Industrial Line as well as Premium encoders with contactless detection. The Efficiency Line comprises incremental and absolute multiturn encoders. Industrial Line encoders serve special applications with greater environmental requirements and a higher shaft load. Absolute single turn devices also extend the offering of output types. Turck's proven QR24 and QR20 encoders with contactless detection complete the product portfolio. More information at www.turck.com/encoder

Linux Expansion for RFID-UHF Readers

Turck is presenting a Linux variant of its versatile Q300 RFID-UHF reader. The operating system particularly offers benefits for system integrators who can carry out extensive programming on the read/write head – for example, for the decentralized preprocessing of data or for connecting to higher-level goods management systems. The Q300 was put on the market a year ago as the "Multitool for Industry 4.0". The two-watt reader makes it possible to connect up to four passive UHF antennas and can be used, for example, in applications with bulk detection. Trigger signals or LED lights can be controlled via the four digital I/Os. In addition to the existing Codesys and new Linux variant, Turck is also presenting Q300 devices based on Windows Embedded Compact 2013 as well as OPC-UA.



RFID & WIRELESS IOT SEARCH ENGINE

RFID & Wireless IoT online

This platform was conceived from the necessity of providing all relevant information on wireless technologies for IoT in one place.

All Wireless IoT Tech Providers benefit when their products, solutions, and services are visible in the Search Engine.

They are available online 24/7 and are transparent for every customer.



SUPPLIER



PRODUCTS



NEWS



PROOF OF EXCELLENCE



CONTACTS

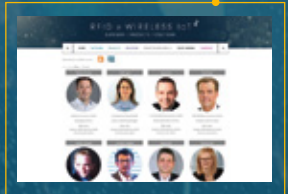

Join the Search Engine!

This platform was conceived from the necessity of providing all relevant information on wireless technologies for IoT in one place.

www.rfid-wiot-search.com

QUICK READ

Extremely fast, compact, robust and secure: The TBEN-L managed Ethernet switch combines these properties and enables the decentralized distribution of Ethernet connections directly at the machine. With two GBit high-speed backbone ports, the switch provides enough bandwidth for the high-performance data flow of the eight standard ports (100 MBit/s). Supported by superfast link-up times and cut-through forwarding, the switch ensures fast cycle speeds, even with tool changing applications. In many applications it therefore saves wiring effort and supports modular machine concepts without a control cabinet.

Safe Turbocharger for IIoT

The TBEN-L-SE-M2 managed high-speed switch with protection to IP67 offers maximum data throughput, superfast link-up times and secure industrial Ethernet networks

Data networks are frequently compared to road traffic. In this image, the cables are roads and motorways, and the switches represent crossings and motorway junctions. The task of the switch is to combine the data of many Ethernet stations on a main cable. The main cable can normally transport more data per second than the individual feeder lines.

Just like road traffic, data traffic is also constantly increasing. This development can be observed in office IT, in private households as well as in individual networks and operational technology (OT). The convergence of OT and IT is also boosting the increase of data streams. These must be ordered and distributed by switches. These consist of passive so-called “unmanaged” switches or active “managed” switches. While unmanaged switches basically only combine cables, managed switches actively control the data flow, prioritize it, assign IP addresses if necessary, establish redundant connections and secure the access to networks using firewalls.

Efficient wiring with IP67 switch

As IP67 specialists, Turck has for a long time been making possible the “Out of the cabinet” decentralization of automation technology. Besides the conventional I/O modules for connecting digital or analog signals or IO-Link devices to Ethernet networks, controllers and spanners for translating between Ethernet languages have also been set free from the control cabinet. The wiring and flexibility benefits arising from decentralized cabinet-free installation also apply to switches. Ethernet cables to the stations do not have to be routed individually from the control cabinet, but are only routed at the machine to the stations over the last meters. Depending on the system topology, the decentralized positioning of the switches saves considerable wiring effort.

Drag chains, redundancies, safety

Of course not every system requires a switch or several switches at the machine. Connecting stations with

Premiere at the SPS Fair
in Nuremberg: Turck's
TBEN-L-SE-M2 managed
high-speed switch with
protection to IP67



linear structures is certainly a major benefit of fieldbus- and Ethernet networks. In many cases, however, a star structure is required and so a switch is necessary: In drag chain applications, for example, it is highly impractical and laborious to route Ethernet cables at the end of the drag chain as a line. Several ports are likewise required when creating ring redundancies. The increased availability requirements placed on machines are another reason. A ring structure or a star structure offer the highest level of reliability. With star structures, each station is connected to a separate port of the switch. Different line structures can be created via switches according to the particular machine architecture.

1Gbit high-speed backbone and port-based IP address assignment

Turck's new 10-port switch in the proven TBEN-L block module design offers 100 MBit/s on eight ports and 1 GBit/s on two high-speed backbone ports. The switch in the robust IP67 design is unique. It optimally meets the requirements of high-performance industrial applications in harsh environments. Users can assign the IP addresses to stations either by port or centrally via the web server of the switch. This saves the user having to make separate configurations for each individual station. For series machine builders and users integrating machines in higher-level networks, the switch with NAT routing offers higher-level systems the possibility to assign proxy IP addresses and thus prevent the doubling of IP addresses in networks.

X-CODED ETHERNET CABLES

Ethernet cables with X-coded M12 connectors to suit the IP67 switch, which can transfer up to 1Gbit/s, are now also available. Turck is thus expanding its range of conventional Ethernet cables for industrial applications which were only previously D-coded for transfer rates of up to 100 MBit/s. These Ethernet connections are available with M8, M12, RJ45 or flange connectors in lengths between 0.5 and 25 meters.

The embedded firewall ensures managed and above all secure data exchange for the integration.

High-speed tool changes with quick link-up times below 150 ms

The fast link-up time is a requirement which many industrial switches fail to provide. The ability to establish connections to stations in the shortest possible time is much more critical in industrial automation than in home or office IT scenarios. This must be carried out in fractions of a second, particularly with tool changes such as for car body manufacturing in the automobile industry. If there is a switch between the controller and station, the deployment of the tool not only depends on the startup time of the Ethernet station on the tool but also the link-up time of the switch. The quick link-up technology of the TBEN-L switch makes the tool changer operational in less than



Only the X-coded Ethernet cables with M12 connectors and 8 pins enable 1Gbit/s high-speed networks also with IP67 components

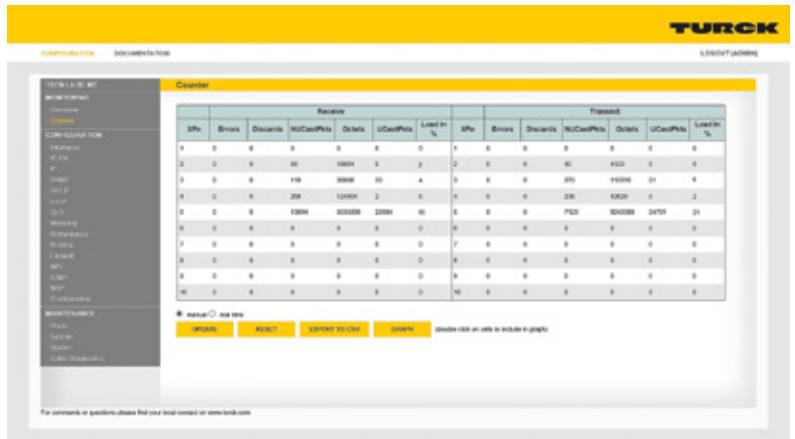

The network load monitoring of the switches always give the user an up-to-date overview of the Ethernet connections



broadcast waves can put switches and other devices at the limits of their capabilities. The integrated broadcast storm protection reduces these kinds of network load spikes.

Virtual networks can also be set up for control via broadcast domains. These VLANs can then be used like individual networks and configured with VLAN-specific bandwidths. Broadcast requests are thus only functional in the virtual LAN. VLANs are also used to separate production and management data, which in turn effectively protects the availability and security of the production network. The network load monitoring of the switch helps on all ports to diagnose impending overloads early on and makes it possible to make predictive interventions.

150 milliseconds. This therefore makes it one of the fastest switches on the market.

Multicast, load dump and 10...30 V for mobile equipment

The mobile equipment sector is a market for which you don't automatically think of switches. Switches are required here for connecting IP cameras which increasingly support the automation of agricultural machines. They show farmers live pictures of their machines – either directly in the driver's cockpit or for driverless systems in the office. The agricultural manufacturers also use the monitoring functions that display the camera image automatically on the screen if an unusual movement was registered. The camera images of the machines have to be managed via a switch and made accessible to the controller.

The multicast capability of the TBEN-L switch makes it possible here for several screens to display the video streams with no latency and at an optimized bandwidth. The wide 8...30 volt input voltage range is indispensable in order to be used in devices with a 12 volt onboard network. The so-called load dump capacity of the switch is also important. This test verifies to the switch that it can compensate voltage spikes as they can arise when the voltage is disconnected.

Wave breakers for broadcast and network load monitoring

Ethernet stations can send so-called broadcast requests which are directed to all stations of a network. These

Conclusion

Such a compact and powerful switch like the TBEN-LE-M2 has never existed on the market before. The combination of protection types up to IP69K and high-speed backbone with two GBit ports is ideal for depicting the increasing networking of ever higher data rates in industrial networks. With fast linkup times below 150 milliseconds, the switch offers the highest cycle rates for tool changers in robot technology.

The user also benefits from the several functions for the safe and efficient organization of industrial Ethernet networks. The integrated firewall therefore offers bidirectional protection from unauthorized access and thus reliably increases security in IIoT. This is in addition to the NAT routing capability or the possibility to set up virtual LANs.

Author | Aurel Buda is director production management factory automation systems at Turck
Webcode | more21900e

Further information: www.turck.com/switches



»Safe Turbocharger for IIoT«

Mobile Maschinen

XING

THE STRONG NETWORK OF EXPERTS!



Connect with the experts and join the discussion – in our XING Expert Forum.

JOIN THE XING GROUP NOW:

<http://bit.ly/MobileMaschinenXING>



Mobile machines – construction, Development, engineering of construction machinery, Agricultural machinery, etc.

Everything around the engineering of mobile working machines. A group of the trade journal **Mobile Maschinen**.
www.mobile-maschinen.info

**THE FORUM FOR DESIGNERS OF MOBILE WORKING
MACHINES AND THE SUPPLYING INDUSTRY.**

Take advantage of the expert knowledge of the industry insider and get to know the latest news about trade events, trade fairs, latest technological developments and trends!

You can also find Mobile Maschinen here:



XING

»As SIDI uses the Profinet mechanism, the data of the IO-Link parameters is stored in the engineering project«

Sai Seidel-Sridhavan | Product marketing manager

With SIDI (Simple IO-Link Device Integration), Turck's IO-Link masters enable the integration of IO-Link devices directly from the Profinet engineering – without any additional software or programming needed. Turck is thus opening up the engineering benefits of the Profinet world also for IO-Link installations, and in this way making the IO-Link standard also attractive for die-hard Profinet fans. Frank Nolte, deputy chief editor of technical journal etz, spoke to Turck's product marketing manager Sai Seidel-Sridhavan about IO-Link and the new tool.

Mr. Seidel-Sridhavan, why has the integration of IO-Link devices in Profinet systems been so complicated to date?

IO-Link commissioning tasks are normally carried out with an IO-Link tool. However, these tools always have to be started from engineering tools or externally and are therefore ultimately separate to the usual user's environment. A real integration in Profinet systems has not been available for this.

Weren't the IODD interpreters developed for this?

Although the IODD interpreters are part of these tools, they do not support the integration in Profinet systems. IODD interpreters only provide for the human-readable implementation of the IODD file, which with its XML format is more suitable for machines. Tools are thus able to process the structures and texts contained in the file and support the user in commissioning, but just not the integration in Profinet.

Does your new SIDI function for IO-Link masters now provide a solution?

SIDI enables users without the tools mentioned to configure a system directly in a Profinet engineering software such as TIA Portal. In this way IO-Link devices can be set for commissioning with a minimum of effort. For this, we use existing Profinet processes that users are already familiar with and supplement them with IO-Link relevant information. SIDI offers you some of this work already prepared and enables you to concentrate on the essential properties of the devices. When the device configuration for your machine is completed, you also automatically integrate the IO-Link devices via the GSDML of the IO-Link master – just like all other Profinet device.

What are the outstanding features of SIDI?

Its usability. Straightforward processes always shorten the commissioning times required. Imagine having a number of IO-Link devices that you have to integrate in the configuration. Generic devices can

be selected in the device configuration of the IO-Link master. These can be used to integrate all IO-Link-capable components that are available on the market. You already have here the possibility to assign the IO-Link port uniquely via the vendor and device ID and define the process data width. However, you can obtain even more data in advance for some components on the market. This therefore naturally completes the integration of devices from different manufacturers and of course also from Turck in the GSDML.

What does that mean exactly?

Users can already see the product name and the manufacturer in plain text when selecting the device. They can choose the device and thus also have access to the IO-Link parameters of the IO-Link devices in addition to the vendor and device ID. The user therefore no longer has to integrate the IODD separately since this information is already provided. This means a considerable time saving and thus offers

our customers a clear benefit. As SIDI uses the Profinet mechanism, the data of the IO-Link parameters is also stored in the engineering project. This means that users can choose for themselves whether to trust the IO-Link data or the Profinet variant. While both are possible, their degrees of acceptance vary.

Is the function integrated as standard in all your IO-Link masters, and does it cover all IO-Link sensors from Turck?

All Turck block I/O modules with an IO-Link master come already factory shipped with the SIDI function. This applies to the products of the TBEN series with IP67/IP69K protection and the IP20 FEN series with multiprotocol operation, as well as the safety hybrid modules of the TBPN series with Profisafe and Profinet. All Turck's IO-Link devices are already integrated.

How open is the library? How can the IO-Link devices of third-party suppliers be integrated?

Turck's entire IO-Link portfolio and also the IO-Link devices of our optical sensor partner Banner Engineering are included in the GSDML. Some other market relevant devices in the actuator field are also included. This list of third party suppliers is being continually checked and extended. The file is regularly updated as soon as new components are added at product launches.

How is compatibility and functionality ensured?

Each component in SIDI is tested and checked on the IO-Link masters by our integration laboratory. The functionality is ensured through the standardization of Profinet.

Wouldn't something like the IODDfinder also be ideal for SIDI?

A flexible GSDML that is fed from the IODDfinder cannot be implemented today. Turck has fully integrated the IODDfinder in the IODD DTM interpreter, which supplies the PACTware configuration software. This offers the clear benefit of the IODDfinder in finding connected devices quickly. A complete integration of IODDs with the IODDfinder in an engineering system would definitely be the logical solution here.

Author | The interview was conducted by Frank Nolte, deputy chief editor of technical publication etz elektrotechnik & automation

Web | www.etz.de

Webcode | more21930e



On the Pulse of the Machine

Existing plants can be made fit for condition monitoring in no time at all using smart sensors and flexible solutions for data transfer and visualization

Building from scratch is often not always trouble-free but there is a clear benefit: Requirements can be taken into consideration early on in the new structures. This also applies to maintenance. Anyone planning a modern production plant or a logistics center can equip machines and plants with smart sensors in order to selectively query the status data of individual devices or areas at a later time. Performing inspections remotely and efficiently planning maintenance – thanks to fast fieldbus networks and industrial Ethernet.

What do you do, however, if the system architecture comes from a previous decade? This is normally the case in practice, with all the associated challenges for the technical personnel. When implementing smart condition monitoring in an existing plant, maintenance technicians face many obstacles: How should the retrofit be successfully completed without any intervention in ongoing processes? Does the control system have to be adapted? How do I access information on machines that are difficult to access?

Motor monitoring as a retrofit

This is where tailored stand-alone solutions come into play, from basic local monitoring tasks right through to wireless communication and the transfer to cloud environments. The idea: Companies can easily add at a later time devices by which they monitor machine values within an independent system. Status data can then always be transferred to the customer's automation world if required, with the existing architecture always however remaining separate to the operation of the condition monitoring expansion.

The monitoring of motors is a widely used application of this approach. These drive pumps, compressors or exhaust fans, and are often run in noisy uninterrupted duty in locations that have so far been difficult to reach for maintenance. A regular inspection by employees cannot exclude the possibility of an impending machine failure with a high degree of certainty; onsite inspections are also mostly difficult. Monitoring through the use of measurement devices is not only more reliable but also more economical. They can

The QM42 vibration and temperature sensor can be fitted directly at the motor and can transfer data from there to a wireless module

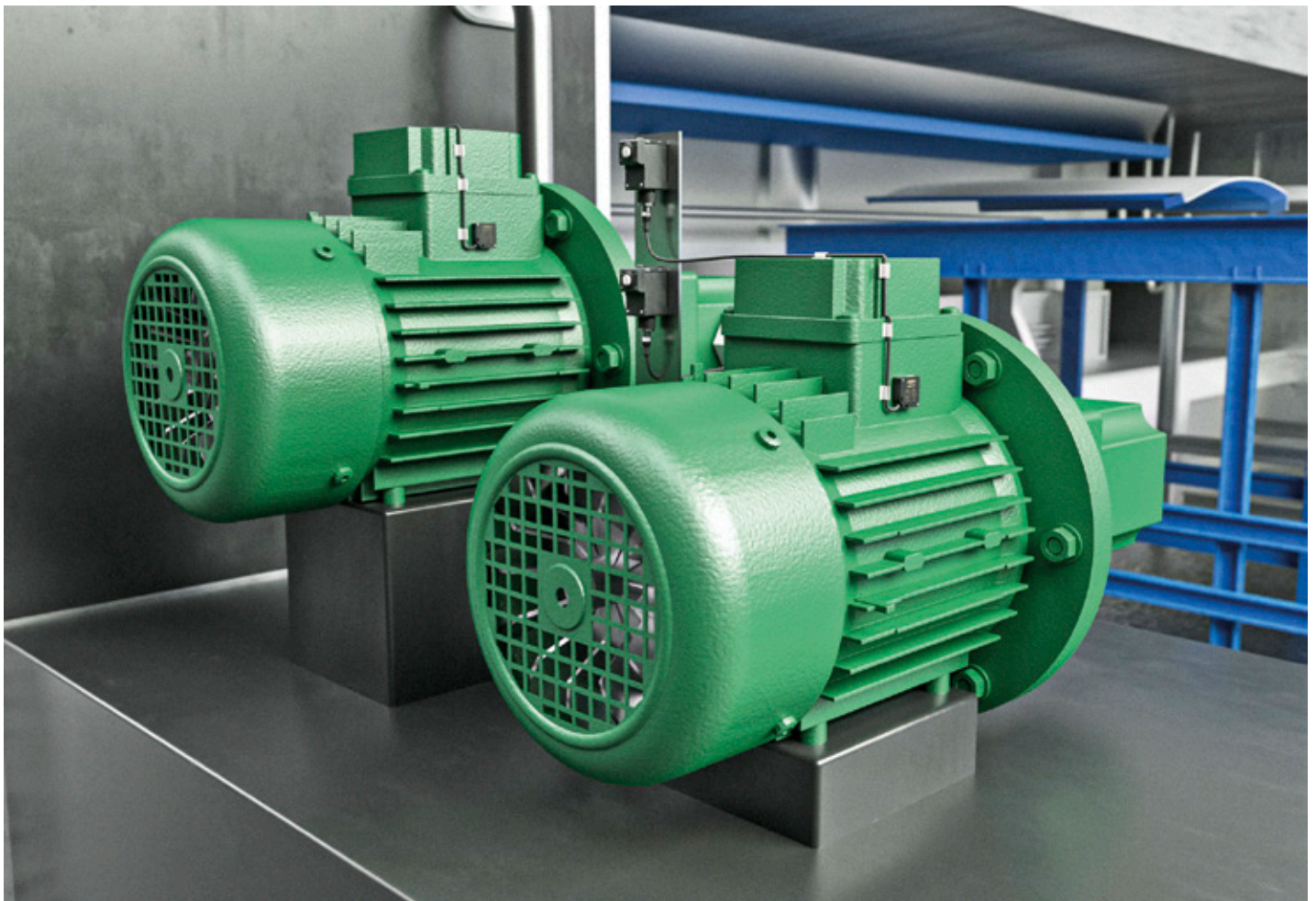

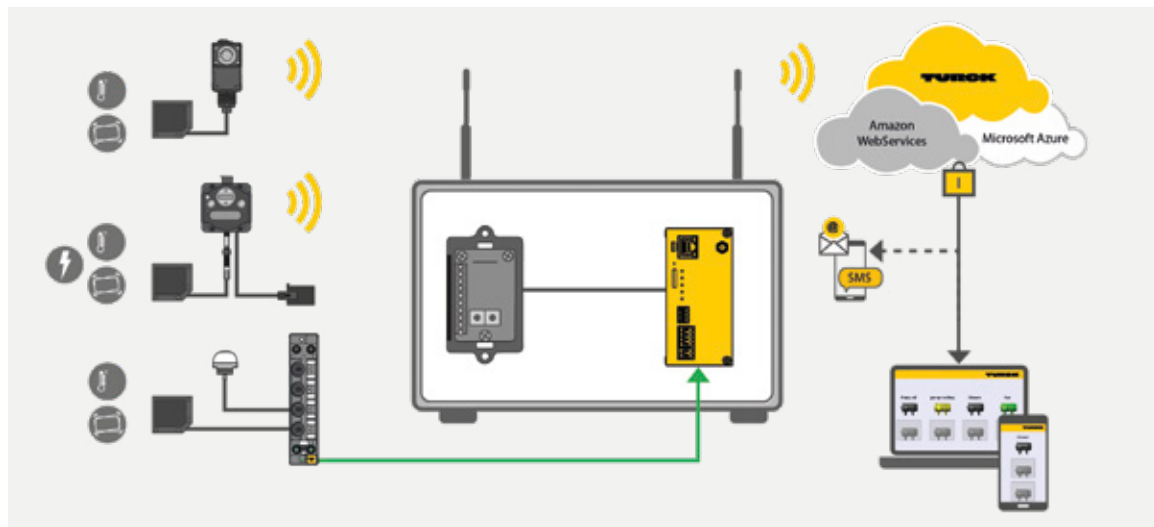
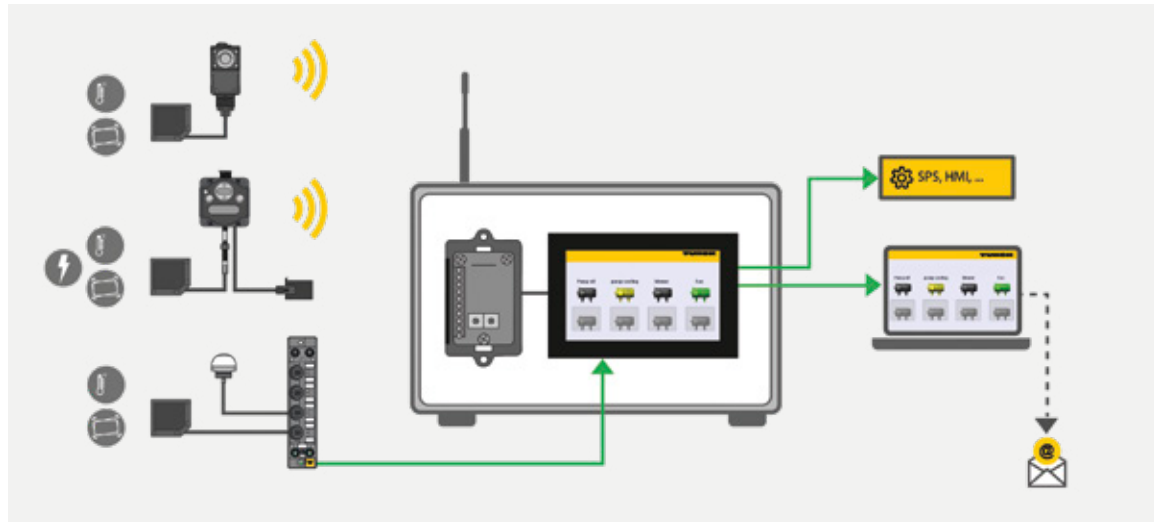

Free choice: In this schematic diagram of an example application, the sensors send temperature and vibration data either wirelessly or wired to the TX700 HMI, which in turn forwards the data to a PLC or a cloud wirelessly or by cable

measure three different values: vibration, temperature and current.

IP67 sensor monitors vibration and temperature

Irregularities in a motor sometimes announce themselves several months before the actual failure. An incorrectly adjusted shaft, a sticking bearing or imbalance in an attachment will change the frequency in the vibration. To detect these, maintenance engineers can fit the QM42 vibration and temperature sensor directly to the motor block. The compact sensor with IP67 protection is fitted easily and securely with magnets. It is based on a microelectro-mechanical system (MEMS) and thus supplies high precision velocity and acceleration data in two dimensions. The QM42 also outputs a temperature value, and registers therefore in the temperature range from -40 to 105 °C, whether and where the motor has overheated, and thus allows the monitoring of temperature trends.

The current required by the motor is also helpful here. If there is any damage to bearings, or if the lubrication is not correct, the mechanical resistance will make more current necessary to reach the required speed. A measurement transformer can be used for monitoring.

Data transfer in the wireless network

These measured values can be used in different ways and can be transferred in both wired and wireless networks. In some machine halls, a decentralized alarm system, for example, consisting of the QM42VT2 sensor and Turck's compact TBEN-S2-2COM I/O module are

QUICK READ

The lack of the necessary technical requirements and the ongoing production processes often impede the later introduction of a condition monitoring system in existing industrial plants. Turck offers easy to install sensors and suitable data transfer and monitoring solutions especially for these kinds of brownfield projects. Directly mounted on the motor, Banner Engineering's QM42 vibration and temperature sensor supplies for example measured values, which reach an HMI via a wired or wireless connection or can be sent with encryption via Turck's TCG20 cloud gateway to mobile terminals.



The data visualization on the TX700 HMI/PLC also puts everything in view for the user, even directly in the field

perhaps all that is needed to meet the requirements. Thanks to the integrated intelligence through the ARGEE programming environment, the fieldbus module takes over PLC functions if required and transfers the information of an overshoot threshold value directly to a signal light. Alternatively, the TBEN module can also be connected with an HMI device.

Even more flexibility is provided by a wireless transfer within Banner's proprietary DX80 wireless system. For this a device like the QM42VT1 vibration and temperature sensor is connected serially with a transmission module (node) which sends the data to a receiver (gateway). In order to also determine changes in current consumption, users can use a special DX80 node which offers an additional input for the signals of a transducer. If required, the wireless nodes can be battery-driven so that no additional power supply has to be laid. This considerably reduces the required wiring effort. Added to this is the possibility to implement the monitoring precisely at the ideal location.

This may, for example be a central control room. The wireless gateway and Turck's TX700 HMI can be linked here to display the status data of several machines with the VisuPro software, to extract log files or to configure alarms. The data transfer does not have to end at the HMI since other destinations are made possible via an Ethernet connection: the Internet browser for visualization in WebVisu or for sending automatic email notifications, as well as the in-house automation environment (PLC, HMI etc.).

From the cloud to the mobile terminal

Condition monitoring, however, is not restricted to physical displays and signal transmitters in the plant. The TCG20 cloud gateway can also further process the data of the DX80 receiver module instead of the HMI. This allows the machine values to be sent to the Turck cloud via the mobile network or via Wifi, optionally hosted also without an Internet connection as a private cloud in the in-house IT center. The TCG20 also supports the connection to other cloud environments in exactly the same way. Benefit: Information can be called up day and night on any connected terminal device such as a smartphone or tablet and linked with alerts via SMS or email. For this maintenance has access to a cloud portal that consists of an individually configurable dashboard.

Conclusion

With its condition monitoring solutions, Turck is responding to two frequent problems in the field of maintenance. Status values from machines are often not known at all or do not reach the right recipient at the critical moment. A complete toolbox is now provided for both scenarios – from the robust sensor in the machine environment right through to visualization on the smartphone. The motor monitoring application is a clear example: No laborious adaption is required, especially in existing plants. Companies can retrofit condition monitoring simply and build their own additional control system.

Author | Dr. Bernhard Grimm is
director vertical marketing at Turck
Webcode | more21905e

BLAZING A TRAIL FOR PREDICTIVE MAINTENANCE

Maintenance strategies can be divided into three levels. A reactive approach aims to carry out repairs and device replacements only after a malfunction. Preventative action on the other hand means maintenance operations being carried out at fixed times, which are based on empirical values. Condition-based maintenance is based on the evaluation of data from the condition monitoring system together with the real-time diagnostics. Condition monitoring thus provides the fundamental conditions for intelligent forecasts. These provide the basis of predictive maintenance, a core issue of Industry 4.0.

Further information: www.turck.com/condition-monitoring



»Condition Monitoring
in Existing Plants«

BOOST YOUR COMPANY VISIBILITY THROUGH

ONLINE

PRINT MEDIA

IN-PERSON EVENTS

SOCIAL MEDIA

WWW.TIM-EUROPE.COM

MARKETING@TIM-EUROPE.COM

TIMGLOBALMEDIA



400,000 Decision-Makers

12 Media Brands

5 Languages

11 Websites

5 Events

50,000 original contents/year

Editors in 5 countries

Goodbye to the Door Stop

Turck's ultracompact IMXK isolation barriers and analog signal isolators have 35 percent less depth and also fit in compact switch boxes – ideal for module based process automation

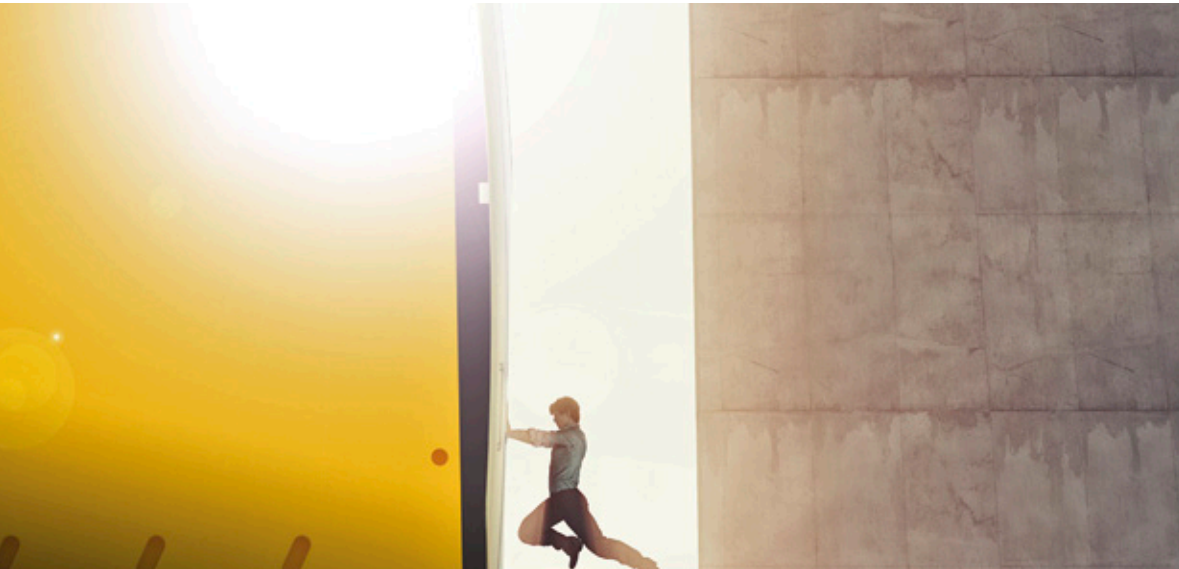

Creating space: The new IMXK interface devices with a 77 millimeter depth are ideal for compact switch boxes

The trend towards modularization in the process industry continues unhindered, and is a response to the increased requirement for more efficient engineering, greater flexibility and shorter times to market. The modularization strategies of many plant builders serving manufacturers of chemical and pharmaceutical products have gone past the trial stage. However, these new processes are not yet optimally represented on the control system level. The Namur working group 1.12 has already outlined in its Namur recommendation (NE) 148 the requirements placed on the automation technology in order to reflect modularized production. The control system manufacturers are still in the process of adapting to the Namur requirements and are agreeing on their solution in the ZVEI Modular Automation working group of the German Electrical and Electronic Manufacturers' Association.

Compact devices for modular process automation

Due to this complex situation, some of the more basic questions still remain unanswered. No standard control cabinets are used on modules for process plants but small switch boxes and housings. These are not only narrower and shorter but also shallower. The latest generation of interface technology often does not fit inside it. Although the devices of all manufacturers have become slimmer in recent years, they also have a greater depth and height. Particularly the depth of around 12 centimeters can already become the "door

stop" in compact control cabinets with depths of only 10 or 15 centimeters.

77 millimeter depth for compact switch housings

For this reason, Turck is adding the compact IMXK devices to its IMX interface device series. With only 77 millimeters they are 35 percent shorter than many of the most common interface devices on the market. Their width of 12.5 millimeters and height of 117 millimeters is virtually a sector standard and corresponds to Turck's conventional IMX devices. The following devices in the IMXK design will come on the market first: Isolating switching amplifiers for digital input signals (IMXK12-DI), valve control modules for

QUICK READ

Conventional interface devices often do not fit in the compact switch boxes of modular plants or mobile equipment since there is not enough space for 12 centimeter deep isolators and amplifiers. Turck has therefore added the IMXK devices with a depth of only 7.7 centimeters to the IMX series. In terms of speed, precision and international approval they match the excellent specifications of the IMX devices but also fit in shallow control cabinets for modular plants.

digital output signals (IMXK12-DO), as well as isolating transducers for analog input signals (IMXK12-AI) and isolators for analog output signals (IMXK12-AO).

10...30 VDC input voltage for mobile use

On mobile devices, the switch boxes are also often smaller than in large monolithic process plants. This is where the IMXK offers another benefit, which it shares with its "larger" IMX siblings: Its wide input voltage

The IMXK design comes in the following variants: Isolating switching amplifiers for digital input signals (IMXK12-DI); valve control modules for digital output signals (IMXK12-DO) as well as isolating transducers for analog input signals (IMXK12-AI) and isolators for analog output signals (IMXK12-AO)

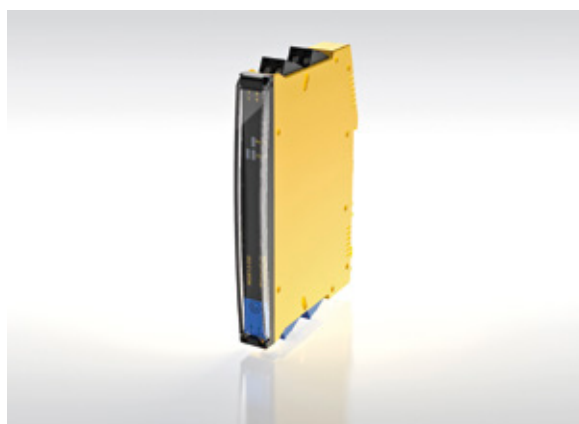

range of 10...30 VDC allows use on machines with a 12 volt onboard network voltage – for example on tankers. This can be critical, particularly in other markets outside Europe. The approvals of the IMXK devices also support their suitability for worldwide use. Besides the IEC Ex ATEX and UL approvals for Europe and North America, the IMXK devices also have approvals for Korea (Kosha), China (Nepsi) and Brazil (Inmetro).

Functional safety and Ex isolation

In spite of their compact design, the IMXK devices have nothing to hide in terms of safety. This applies not only to their core task of conventional Ex isolation but also the functional safety which has increased in importance over recent years. In the beginning, the safety integrity levels (SIL) were equated with quality. However, plant operators gradually developed a deeper understanding of the stringent requirements of IEC 61508. Turck was already able to build on the development and production process used for the IMX series and is now rolling out this experience in the IMXK series. Recognized independent bodies have certified this process. Comprehensive manuals and commissioning guides support IMXK users in the operation of the devices in functional safety circuits.

Maximum accuracy

Turck has managed to increase the performance of the new IMX series in spite of the small depth – in terms of

accuracy as well as in terms of speed. This is demonstrated in the IMXK12-AI EX analog signal isolator. Its electronic design is insensitive to external factors such as temperature or voltage fluctuations. The effect of the interface device on the overall performance of a complete measuring circuit is thus considerably reduced. The device operates much more accurately and thus meets the increased demands of the field devices for accuracy.

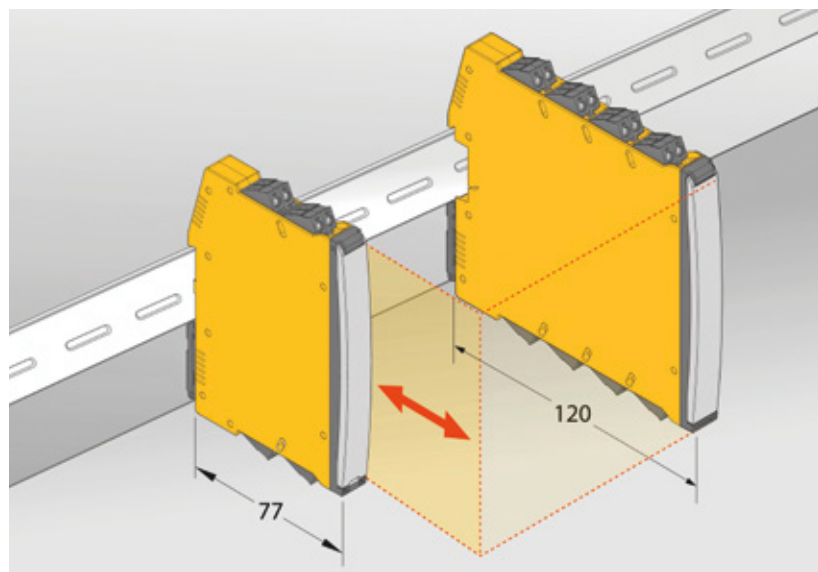

When compared directly with the IMX modules in the standard size the additional space of the new IMXK devices (left) is considerable

However, the linearity error of the devices is not the only factor considered with regard to accuracy. Many other error factors, which often only appear in the small print of the manufacturers' data sheets, should also not be ignored. Data sheets cannot be used as the sole basis of device comparisons. Ambient influences such as temperature, power supply fluctuations or changes in the connected load can have a considerable effect on the performance of devices. Turck specifies these errors and field conditions, and includes effects such as repeatability and hysteresis in the total error calculation. The so-called total performance is calculated from this together with the temperature coefficient. It does not reflect abstract laboratory conditions but the performance in the field. It has been verified that the analog signal isolators and temperature measuring amplifiers of the IMX and IMXK series have the best overall performance in terms of accuracy of all 12.5 mm interface devices.

Author | Klaus Ebinger is director product management interface technology at Turck

Webcode | more21970e

Further information: www.turck.com/imxk



»IMXK: Compact Interface Technology for Modular Automation«



Award Winning Design: The FS+ flow sensor (left) and the PS+ pressure sensor combine a high degree of robustness with innovative operation and are easy to install – the TS+ temperature sensor will soon be added to Turck's fluid platform

Generation Plus

Turck is putting its fluid portfolio on a standard technology platform and is presenting with the FS+ flow sensor the latest member of the series

Unmistakably similar and yet equipped with individual strengths – the members of Turck's fluid sensor series. In April the PS+ pressure sensor had already set high standards with its award-winning design, robustness and an innovative operating concept. This will now also be the benchmark for the FS+ – a compact fluid sensor for monitoring fluid media, which also measures

temperature, supports IO-Link and considerably simplifies commissioning.

Innovative design concept

The devices don't just have a similar appearance or carry the plus sign in their name. In future Turck will be putting its entire fluid portfolio on a standard

QUICK READ

Turck is developing a platform concept with the new product portfolio in the fluid sensors. The devices offer a wide range of variants and combinations while having common key features at the same time. The compact FS+ flow sensor with IO-Link now follows the April market launch of the PS+ pressure sensor. This monitors both flow as well as temperature and features practical Teach functions.

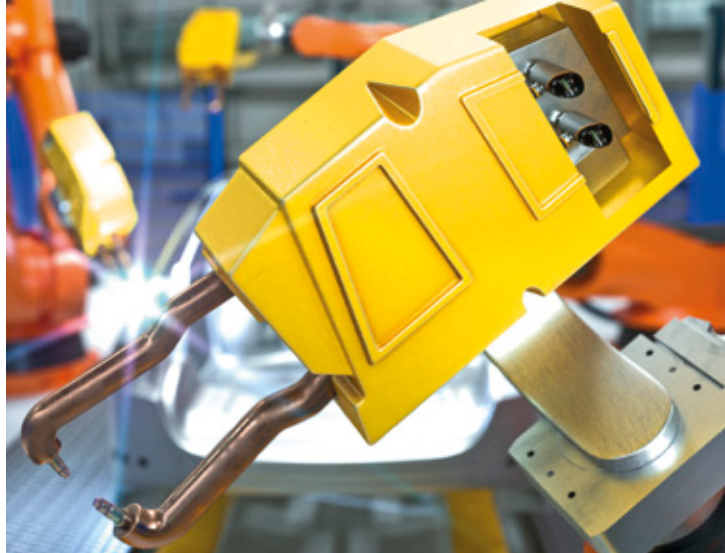

Double protection: The FS+ not only monitors the flow of coolant on the welding robot but also detects any impending overheating of the cooling circuit

technology platform. Sensor users will therefore find many of the same product features and the standard handling concept in the entire series. The modular and freely configurable mechanical concept, shorter delivery times and easier stock management are additional benefits.

The sensor head is the characteristic feature of the compact sensors. This consists of a stainless steel housing and a single-piece translucent front cap. Thanks to the reduced sealing area, humidity and dust cannot penetrate inside the devices, while UV and salt spray resistant materials offer special protection in outdoor applications. The sealing concept enables protection types IP6K6K, IP6K7 as well as IP6K9K, since the sensors no longer have any mechanical operating elements. Instead, users navigate functions like on a smartphone via wear-free, capacitive touchpads.

One sensor for two queries

The new FS+ incorporates the proven technical design. It monitors fluid media according to the calorimetric principle and therefore offers the possibility to constantly measure the media temperature as well as the flow rate. This means that a single sensor can handle two tasks at the same time. Typical application fields include for example cooling circuits in welding applications or cleaning processes, in which the process sequence is controlled.

In the FS100 product series users first have the choice between two different output functions: Either analog (4...20 mA) or as a transistor with automatic PNP/NPN detection and communication via IO-Link 1.1. The switching behavior can be set between "normally open" (NO) and "normally closed" (NC). LED indication that is visible from all sides indicates the state of the outputs, while a bicolour LED strip on the user interface indicates either flow or temperature values.

The FS+ is likewise easy to mount and operate. The probe tip can thus be aligned as required in the medium, and the sensor will operate within its specifications nevertheless. Irrespective of this, the sensor housing can also be rotated around 340 degrees to align the display and electrical connection to a convenient position.

Setting reference values with Quick Teach

The FS+ offers some practical handling features such as a lock mechanism or the ability to reset the sensor to

the previous settings (Undo function) as well as to the factory settings. Two modes are provided for teaching switch points: The Quick Teach function enables users to define a reference flow rate in only a few minutes and set the monitoring of deviations directly on the sensor. Alternatively, maximum and minimum values can also be defined in the application. The innovative Delta Flow monitoring function, which only activates all teach functions if a constant flow has been reached, provides significant assistance. The internal compensation function means changes in media temperature have no effect on the flow measurement.

Outlook

The fluid sensor portfolio will expand even further in future. Based on the platform concept, compact sensors for temperature and level measurement will follow in the generation of plus sensors – easy to integrate, robust and with a functional design.

Author | Dr. Bruno Gries is director product management fluid sensors at Turck
Webcode | more21971e

Further information: www.turck.com/fs



»Flow Sensors for Liquid Media«

FOR REMOTE MONITORING

At the same time as the Plus devices, Turck is presenting the next development level of the FP100 remote flow sensors, which reliably monitor fluid media with the new FM-IM...FX flow modules. This serves applications requiring the use, for example, of sensors with separate electronics due to the restricted space. Thanks to Delta Flow monitoring, the FP100 sensors offers some major benefits for the teaching of reference values. The sensor probe in the medium also operates irrespective of its alignment. The portfolio consists of several process connections and different probe lengths.

Velco uses its own design of the Turck Cloud dashboard. Thanks to the responsive design functionality it can also be used optimally on tablets and smartphones



QUICK READ

The pressurized vessel, rotor gunning machines and injection plants from Velco are used in blast furnaces, steelworks, foundries and in the refractory industry. In order to provide rapid support for customers in the event of malfunctions, the special machines are provided with a remote monitoring function. As the previous solution could no longer meet the latest requirements, Velco searched for a cloud based solution that would allow worldwide remote access via PC or smartphone. After a selection process, it was Turck's cloud solution that was chosen, as it was the only one that could meet all requirements.

Taskforce for Rapid Intervention

Special machine manufacturer Velco uses a remote monitoring solution based on Turck Cloud Solutions for locating error sources and monitoring production parameters

The development of Industry 4.0 has some similarity to the downfall of the Roman empire: Nobody knows exactly when it all started. While it is possible to say when the term gained popularity, any notable milestones can only be identified in retrospect. The Velbert-based company Velco Gesellschaft für Förder-, Spritz- u. Silo-Anlagen mbH could thus also look back on the development of its machines and claim that it already started out with Industry 4.0 in the nineties, when it fitted its products with remote monitoring modules. Velco nevertheless claims to be a traditional down-to-earth company that prefers to make a good impression by offering benefits to the customer.

“Even as a traditional company with a fully developed technology, we also have to deal with the innovation trends in the world market, particularly with regard to machine communication, and generate customer satisfaction with our service,” states Velco CEO Christian Wolf. He thus emphasizes here the fact that a down-to-earth attitude and digitalization combine very well as long as there is a focus on real customer benefits.

Velco special machines renew refractory concrete layers in steel and blast furnaces

This was also the company's aim when it integrated cloud-based machine monitoring. Steelworks operators worldwide use Velco machines to spray their blast furnaces, ladles or channels with refractory concrete. The layer of special concrete is attacked by the slag and heat and has to be renewed regularly. Steelworks and blast furnace operators use a refractory concrete gunning machine for this or outsource the refractory repairs to refractory material manufacturers and processors.

Flying to Abu-Dhabi to turn on the supply line

The machines of the refractory concrete service providers can not only be found in Duisburg or Salzgitter, but also in Abu Dhabi, for example, or India. “The customer wants to know: whether the machine is working or not and whether or not it is operating correctly? Customers want support with remote maintenance,” explains Klaus Küster, head of electrical engineering at Velco. This was our original objective. Companies invest a lot of working hours and travel costs in order to fly service technicians half way round the world, sometimes only to discover that the operator cannot detect minor faults and rectify them. The remote monitoring module was designed to eliminate these kinds of excessive service callouts

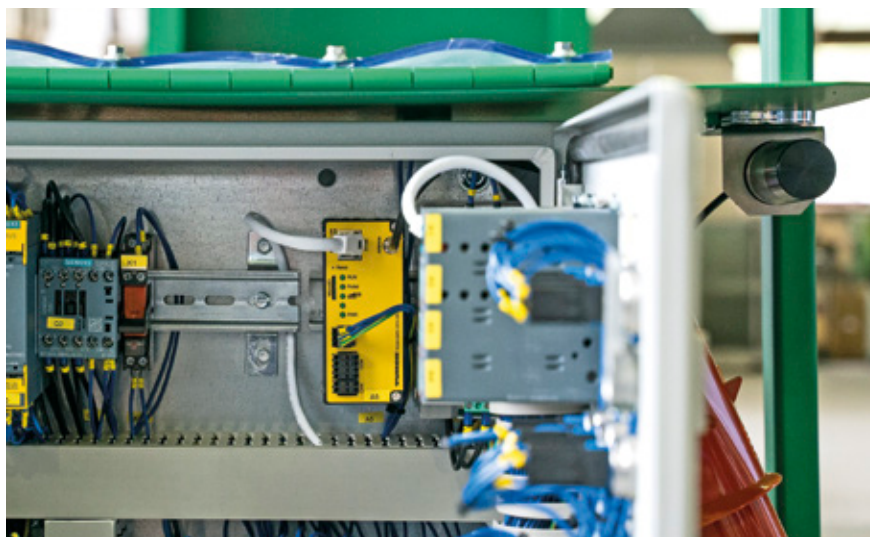

Thanks to the mobile internet connection, authorization for the customer's corporate network is unnecessary, the heavy duty antenna on the right of the control cabinet provides worldwide access to Velco machines – even in the steelworks

for accidentally closed supply lines or the pressing of emergency pushbuttons and at the same time help with the troubleshooting of real malfunctions. The first remote monitoring modules built in the nineties had a limited range of functions and in some places the costs went out of control because the GSM based solution continuously sent SMS messages – with every individual message costing something even when there was no network available. The connection quality was also often unsatisfactory.

Turck Cloud offers outstanding user friendliness

In 2018 Velco therefore looked for an up-to-date remote maintenance solution, by which it could not only view machine data but also allow access to the machines. “We excluded the major cloud vendors because they did not offer any industry-specific solutions. Ultimately we needed a solution that could also operate in extreme environments like steelworks”, Velco electrical engineer Michael Sundmacher explains the basic requirements. After a selection process Turck Cloud Solutions stood out on account of its user-friendliness: “The Turck Cloud impressed us with the fact that a browser allowed with a single click an overview of all machines or the moving between the individual machines. Any noting of addresses is unnecessary and operation is also possible from a smartphone, thus providing direct access to all data for any machine. This

When Velco customers want to diagnose machine states worldwide via their smartphone, heavy metal meets Industry 4.0 – with Turck Cloud Solutions Velco can now help its customer quickly and efficiently with troubleshooting and save costs for onsite service callouts



is also confirmed by our customers and so we chose the Turck solution," Sundmacher explains Velco's decision. Klaus Küster adds: "The key benefit is the fact that we could access the controller of the machine directly via a PC or a smartphone and even control this via Modbus. Other solutions can't offer this."

"Click and happy" dashboard

The customer's employees call up the dashboard of the Velco cloud and see their machines listed in the navigation window. A map in a Google Maps view indicates the location of the individual machines. If an employee clicks on one of the entries in the list, the dashboard provides a clear overview of all the relevant data. Besides some analog values such as water pressure or material level, there are also digital indicators such as for operating state or the status of the emergency stop button. The user can also see an operating hours counter and other numerical displays. The dashboard can be made up very easily by the users themselves – with just a few clicks and without any programming knowledge. "This is really a case of click and happy operation," Michael Sundmacher sums up. Users can also create their own alarm messages via SMS or email for different users.

Customers can also remotely control the Velco machines via the dashboard, if this is required for troubleshooting. The support technicians see from their desk whether the most minor faults such as "missing water supply" or "Emergency stop button pressed" can be excluded. Thanks to the additional data, they are able to effectively support any further troubleshooting.

Automatic material ordering possible

Many innovations appear like icebergs. The expected effect and benefits only constitute the tip of the iceberg. The majority of operating scenarios and side benefits only become evident during daily use. A welcome side effect the cloud: It provides transparency. Refractory concrete users in particular want to see how long a machine is in operation. Depending on



Michael Sundmacher (left) and Klaus Küster have tested many cloud solutions before they chose Turck's solution because "the key benefit was the fact that we could access the machine controller directly with a PC or smartphone and could even control this via Modbus. No other vendor can offer this."

the contract, customers are required to purchase the special concrete of a particular manufacturer. If the consumption values for the concrete do not match the operating hours of the machine, the end customer can assume that other material was used. These kinds of cases enable the rental services to respond in future.

The cloud solution also opens up new sales models for refractory concrete manufacturers. Today they are able to offer and invoice the service according to actual use. This is similar to the use of printers today, which are rarely purchased for work tasks but are hired as a complete service package – including consumable material and maintenance.

Measured value recording simplifies troubleshooting

Support employees often face the problem that many errors only occur infrequently and randomly. Troubleshooting can then take up a lot of time and is sometimes also nerve wracking. In these cases, the support will record relevant measured values over a defined

»The Turck Cloud impressed us with the fact that a browser allowed with a single click an overview of all machines or the moving between the individual machines. Any noting of addresses is unnecessary and operation is also possible from a smartphone, thus providing direct access to all data for any machine.«

Michael Sundmacher | Velco

period. The system outputs the values in a CSV file. In this way, Velco support can identify in future the location of faults more easily. Even algorithms for predictive maintenance could later be used via this interface. This shows how closely the latest automation trends are linked. Cloud solutions simplify condition monitoring and predictive maintenance but are not necessary requirements for it.

Cloud connection even of third party machines

Back to the day-to-day challenges: Some customers also want a Velco cloud for integrating the machines of other manufacturers in the remote maintenance. For this Turck uses a web programmable EDGE gateway which, thanks to the large number of interfaces and supported protocols, can be integrated easily in existing systems with the controllers of other manufacturers and which transfers the machine data to the cloud. This even operates in both directions. Users and customers can thus view, monitor and remotely control all the machines in the cloud dashboard.

Assigning individual user roles and rights

Some users consider the risks involved with remote control as well as its benefits. From the very beginning, Turck has therefore placed prime importance on data and communication security. The management of roles and rights enables the owner of the machine to determine which users can navigate in the cloud and with what authorizations. Different authorization levels can be defined individually for each machine and user, from elementary read rights to write authorization, right through to administrator rights. The communication between Turck's TCG20 cloud gateway and the cloud server is also encrypted via the Kolibri proprietary cloud protocol, which meets the latest standard for data transport in the web (TLS 1.3, AES256).

Mobile communication makes corporate network access unnecessary

Responsible IT managers seldom allow access to the corporate network even when it uses encryption. With

the Turck solution this is not a problem since the TCG20 can also establish the connection to the cloud via the mobile network. This therefore always ensures mobile access to the machines – regardless of where they will be used in the world in the future. The financial investment for data communication via mobile networks is manageable. "Today we use quite normal country-specific SIM cards and everything works. The financial risk is negligible," Sundmacher explains. The TCG20 is nevertheless also available with a Wifi interface as well as a flexible combination device with Wifi and mobile communication. Particularly customers who wish to host their cloud "on-premises", i.e. on in-house servers, will often use the Wifi version.

Conclusion

The overview of the state of all machines is a real benefit for Velco and a strong sales argument compared to the competition. This is how it works with mega trends. All players would like to offer their customers a better product. With Velco, this was the optimum remote access to the machines. Each player advances the mega trend over time and with the increasing number of these kinds of innovations. Even if no-one can say exactly when the whole thing started – for Velco the launch of its cloud was a milestone on the journey towards Industry 4.0.

Author | Sebastian Lindemann is sales specialist at Turck

Customer | www.velco.de

Webcode | more21950e

Further information: www.turck.com/cloud



»Industrial Clouds«

Modular – with Safety

AWL-Techniek is a company offering scalable safety technology directly on the modules of its M-Line machine platform – implemented with Turck's IP67 IO-Link and safety I/O concept

A TBIL I/O hub brings the signals of the welding cap cutter to the IO-Link master (in the background)



Anyone designing a kitchen in an online configurator will experience modularity par excellence. The individual modules here consist in turn of modules for the side panels, the base panels, rear panels and drawers. At the end of the process you can choose the fronts and front panels from different styles, a handle design and a matching worktop.

The example of the DIY kitchen shows clearly that modularity is inconceivable without standardization. Only when the clearances, dimensions, drill holes and connections for water or gas are defined can the benefits of a modular production strategy be used: a large range of variants and great flexibility with short lead and delivery times and moderate prices.

Matthijs Varwijk uses these and other arguments to persuade interested prospects and customers about the modular machine concept. Varwijk is an R&D project manager and is also responsible for the modularization strategy at the Dutch machine builder AWL-Techniek situated in Harderwijk. With over 750 employees at five sites worldwide, AWL has made a name for itself with its automated welding and connection lines, particularly in the automobile sector. Major car builders, suppliers and many other customers worldwide use the machines of the Dutch company in their production lines. An interdisciplinary team around Varwijk implemented modularity in AWL's

QUICK READ

AWL-Techniek's M-Line series makes it a trailblazer in the modularization of production lines. Turck was able to optimally support the Dutch machine builder with a decentralized safety concept with IP67 protection. The combination of IO-Link and hybrid safety I/O block modules saves a lot of wiring work because the entire safety architecture can be installed outside of the control cabinet. The consistent galvanic isolation of the sensor and actuator voltage enables the decentralized safety disconnection of actuator groups on the I/O hubs with IO-Link. The binary interface supplies valuable diagnostic data for Lyla, AWL's dashboard solution for displaying and evaluating the data. The project proves how modular machine construction can create flexibility and shorten lead and commissioning times.

»We need a partner that also suits us globally. We have found one with Turck.«

Matthijs Varwijk | AWL-Techniek

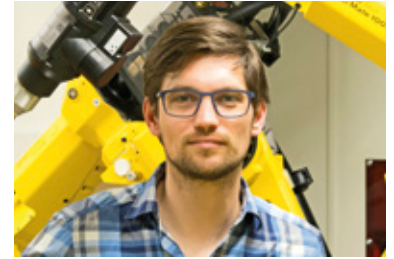

machine portfolio in 2017 and gradually defined the standards of the M-Line. This initially required some persuasion in-house. Particularly in the transition phase from the conventional to the modular production layout, the benefits are not always clear to see. Standards have to be defined first of all, and this often also involves a lot of restrictions.

Frameworks create flexibility and save costs

The first standard set by AWL was the name of the product series: The M-Line represents a modular product series as well as standing for "line" as in "production line" in which the individual modules are combined. The basis of each module is the rectangular steel frame, which is designed to fit inside an ISO container. This saves time and costs when transporting and commissioning the machine. The customer can also expand or convert the system easily at a later time since the modules can be rearranged again in the production hall using suitably designed fork lifts.

Modularization needs standards

Besides the basic frame, three central module types were defined from which the M-Line is to be built: an operator module, in which a worker can insert compo-

nents and start processes, an indexer module, which consists of turntables or other devices for handling the workpieces, and a process module, which processes workpieces, such as with welding robots or machine tools.

The aim: an empty control cabinet

AWL benefited here from Turck's Ethernet multiprotocol technology for I/O modules. It enables the manufacturer to use identical IO block modules in each M-Line module – regardless of whether the customer prefers a Profinet or an Ethernet/IP controller. "We wanted as many standardized components as possible and also a largely standardized control cabinet. Ideally, we will one day just have a PLC and a power supply unit in the control cabinet," van Kooij announced. We haven't got there yet but there is already a lot of air in the control cabinet of the AWL modules. This is also helped by Turck's IP67 I/O hybrid components for standard and safety signals.

Impressive IP67 IO-Link safety I/O concept with scalable safety technology

AWL was impressed by Turck's concept of a modular IP67 IO-Link safety solution: The core of the solution

The different modules of the M-Line can be combined to form a complete production line



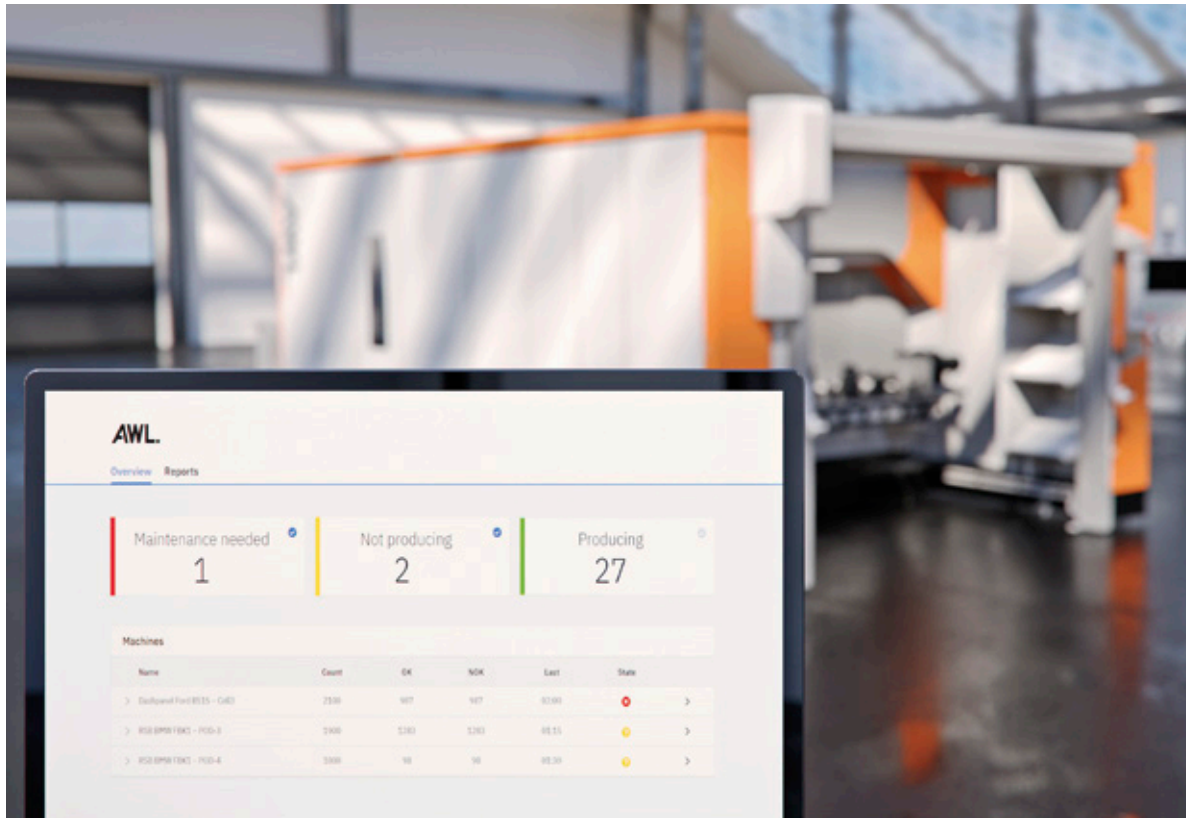

The Lyla dashboard system collects data from different machines, evaluates it and thus monitors operation and performance

is the TBPn hybrid safety I/O module. This comes with an integrated safety controller which can talk to the PLC via PROFIsafe over Profinet. The module is provided with four safety I/Os, two conventional digital I/Os and two IO-Link ports. The TBSB safety disconnection box,

with the Class B standard. This separates the voltage for the sensors (V1) from the actuators (V2). In this way the safe disconnection of the power supply is ensured also via IO-Link. AWL had already used Turck's TBIP module in similar projects in the USA. It has a similar hardware design to TBPn, although it is intended for EtherNet/IP and CIP-Safety communication.



»Only Turck could provide us with the complete offer and the consistently isolated V1 and V2 circuits.«

Jasper van Kooij | AWL-Techniek

Galvanic isolation of sensor/actuator voltage

“Other manufacturers also have modules that claim to separate V1 and V2. However, on closer examination this is not consistent and V1 and V2 share for example the minus pole,” hardware engineer van Kooij explains his criticism. If a short circuit occurs, the shared ground can be fatal. A simple isolation fault is then enough to cancel out the entire safety solution – one of the reasons for ensuring the consistent electrically isolated system. “Only Turck could provide us with the complete offer and the consistently isolated V1 and V2 circuits.”

which safely switches off the actuator voltage V2 in a serious situation, is connected to one of the safety I/Os. The power supply for all modules runs likewise via the safety disconnection box. This ensures that no actuator is supplied with power, for example, in the event of an emergency stop and nothing can move anymore in the machine. The sensors remains active as these are fed via V1. In this way the machine is always visible in the controller. The digital sensors and actuators of the welding cap cutters is connected to I/O hubs, which in turn communicate with Turck's TBEN-L-8IOL IO-Link master. The IP67 block provides four IO-Link ports in accordance with the Class A and four in accordance

IO-Link boosts standardization

The use of the IP67 solution including safety and I/O hubs with IO-Link saves AWL a lot of wiring work. As IO-Link devices, the hubs transfer the digital signals of actuators and sensors in the IO-Link protocol and bring them to the IO-Link master, where they reach the controller via Ethernet. For van Kooij and Varwijk, another reason was the fact that the bidirectional interface boosts the standardization of the M-Line. The safe signal transfer via three-wire cables eliminates the need for specially shielded cable types and special cables. IO-Link also ensures higher availability of the



The entire safety technology of the module runs via the TBPN (below left). The IO-Link master (below center) is supplied via the safety box (center) and can thus ensure that all actuators on the Class B ports are switched off in an emergency



Everything out: Thanks to the decentralized I/O concept there is a lot of space in the control cabinet of the modular machine

machine: The Lyla dashboard system is part of the M-Line. This collects the data of different machines, evaluates it and thus monitors the operation and performance of the machine. This is also possible through the use of diagnostic data via IO-Link.

Global automation partner wanted

AWL builds the latest M-Line generation for a German car manufacturer and its supplier. Besides the IP67 concept, the Dutch company values its project partner Turck for the fact that it is a globally placed automation partner that can even offer and support the same solutions for automotive projects in the USA, Mexico and China as in Europe. "We need a partner that also supports our global requirements. We have found one with Turck," Matthijs Varwijk sums up.

Scalability speaks for M-Line

The modularization of the controller level has not yet taken place. Every control project so far still has to be started from scratch and only function blocks can be reused. The modularization project is anyway never finished. The M-Line is being very well received by AWL's customers. They consider the scalability of the machines to be a major benefit. Replacing an operator module at a later time with an automated solution in order to increase output is not a problem. It's just like with kitchen units: When you move, you simply take the kitchen units with you and add a few modules.

Author | Michael Fleisch is product manager for safety systems at Turck

Customer | www.awl.nl

Webcode | more21951e

DECENTRALIZED SAFETY DISCONNECTION

The concept of decentralized safety disconnection is based on the idea that in the event of an emergency the power supply of each actuator does not switch off individually but in groups of actuators. This eliminates the need for expensive safety outputs, since only one safety output is required for each group. In order not to de-energize all the sensors and actuators of a group, the I/O components separate the power supply of the sensors (V1) from the supply of the actuators (V2). The actuator voltage can then be disconnected safely. As with conventional safety technology, the sensors that are supplied via V1 can continue to send signals after an emergency-stop. The concept can now for the first time be implemented in the field outside the control cabinet with Turck's TBSB decentralized disconnection box with IP65 protection.

Each conveyor element has its own controller: With their suitability for operation at ambient temperatures of -25 °C, Turck's TBEN-L-PLCs can be mounted directly on the line

QUICK READ

For Asbreuk Service, modularity was a key requirement when the special machine builder installed an automated shuttle transport system between the factory of a major food manufacturer and a coldstore. The intralogistics system for conveying pallets consists of elements that are remotely controlled by Turck's TBEN-L5-PLC compact IP67 modules – even at ambient temperatures of -25 °C. Multiprotocol I/O modules expand the range of inputs and outputs at specific points, while K50 lights from Banner Engineering are used to indicate any faults along the line.





Turck's FEN20 devices make the switching signals of the control consoles bus-capable

Cool Heads

Asbreuk Service B.V. equipped a Dutch logistics supplier with a fully automated and modular loading and unloading system for trucks – with the decentralized control at ambient temperatures of -25 °C provided by Turck's rugged TBEN-L-PLC IP67 modules

The products of a prestigious manufacturer of deep-frozen French fries have their own shuttle service not far from Amsterdam. The trucks of the contracted logistics supplier operate a shuttle transport service every half hour between the production plant and the gigantic coldstore located only a kilometer away. The pallets are loaded entirely automatically in no more than two minutes. The synchronized flow of material is reminiscent of scenes from the SimCity computer game series, the only difference being that coworkers still sit at the steering wheels of the trucks and initiate the loading command.

Maximum flexibility was the central aim of the collaboration between the food manufacturers and their logistics partner. The central warehouse with a capacity of 40,000 pallets now replaces the by far more complex transport processes, which involved many different third party trailers supplying the production sites directly. The goods are now allocated instead directly in the modern XXL coldstore. All customers, particularly the major restaurant chains, are supplied from here. The logistics company is not only the service provider that provides the trucks, but also runs the warehouse together with the connected conveyor and transport systems. Invoice calculations are based on each pallet processed.

Flexibility thanks to the decentralized control modules

Automatic loading and unloading is an essential process in the transport of goods over short distances. Asbreuk Service is a family owned company with its headquarters situated near Enschede in the Nether-

lands. It has an outstanding track record in planning and implementing the right technology for the customer's application. The special machine builder can draw on its many years of experience in handling projects for the drinks industry. Major breweries in this sector for example load the entire volume of products and empty bottles automatically via a truck. Key finding of projects so far: The technology should be as adaptable as the business arrangement requires. "If a contract is changed or perhaps extended or reduced in some way, it is important for a system to have a modular design – just like Lego bricks", stresses managing director Marco Asbreuk. In consultation with Turck, his company therefore developed an entire conveying system made from segments, in which both frequency transducers as well as the robust TBEN-L-PLC IP67 controllers are deployed in decentralized operation.

For Asbreuk, modularity means that these kinds of projects involving complete systems are first and foremost economical. "This is only possible if we build series elements that can be installed easily." This was the case with the latest collaboration. The installation of the new line could this time be completed faster than the removal of the centrally controlled legacy system. The modern conveyor system elements thus retain their value over the long term as they can be deployed at a different location or in a different configuration if necessary.

Robust PLC reduces cabling

Next benefit: The decentralized modules require considerably less cabling; According to Asbreuk, this enables an "enormous saving in costs, particularly in

»For us it was important for the controller to have the ability to communicate with different bus systems and at least operate at temperatures as low as -30 °C. There is actually only one PLC suitable for this field, and so the decision to use Turck's TBEN-L-PLC was more or less obvious from the start.«

Marco Asbreuk | Asbreuk Service B.V.



Two control cabinets are used for manual control. These contain FEN20 multiprotocol modules, which expand the number of inputs and outputs available

the coldstore area, which requires the use of special cables." The power supply for the conveyor system is thus implemented at only four points. Turck's IP67 block modules with Codesys 3 controllers distribute the power between each other and are also connected via serial interfaces. Once fitted together, the modules detect their neighbors and determine their position in the overall system.

Their ability to be used in cold storage warehouses at ambient temperatures of -25 °C was what attracted the Dutch engineer to Turck's IP67 TBEN-L-PLCs. "For us it was important for the controller to have the ability to communicate with different bus systems and at least operate at temperatures as low as -30 °C," said Asbreuk. "There is actually only one PLC suitable for this field, and so the decision to use Turck's TBEN-L-PLC was more or less obvious from the start."

The compact controller is an important component in the shuttle transport system which consists of three areas: An automated truck loading system (ATL) is installed in the factory, together with the relevant intralogistics system that starts directly at the end of the production line. The goods traffic on the line is then

handled by trucks with special trailers on which the loading area is equipped with chain-driven conveyors. Having reached the central warehouse of the logistics partner, the drivers then press a button to start the automatic unloading of the pallets. In the mean time, the two-row loading zone at the production site then gradually fills up again. A smartphone app supplies live data from both sites so that the driver is always able to see the latest progress.

Autonomous conveyor system with pallet check

In the factory of the French fries manufacturer, Asbreuk Service provided each of the 32 line modules with their own controller. These modules include chain and roller conveyors as well as a section for inspecting pallets. Laser sensors here check whether a pallet is too wide – and is therefore incorrectly packed. The result is first of all written to a barcode label and the system then removes the relevant pallet automatically. Lasers and scanners are connected locally to the relevant Turck PLC. Only an identical TBEN-L-PLC module, which acts as a higher-level central controller and is connected via a CAN bus, is used for removing pallets.

Expansion via multiprotocol I/O devices

A conveyor element with three directions is required to transfer individual pallets from the usual line route to the buffer. As each direction requires a separate RS485 port, one Turck I/O module provides the additional range of interfaces at this node. The ultra compact TBEN-S-2COM I/O module connects the serial interfaces directly in the field to the controller via Profinet so that the RS485 functionality is retained.

Thanks to laser support and the connected TBEN-L modules, each conveyor section knows when a pallet has to be transferred. If a coworker nevertheless has to intervene in an ongoing process, this person can control line sections individually at two modular and decentralized operator panels. Functions such as a controlled stop or the running of an alternative route are possible. Multi-colored K50 lights from Turck's optoelectronic partner Banner Engineering indicate here, for example, the module where the fault is

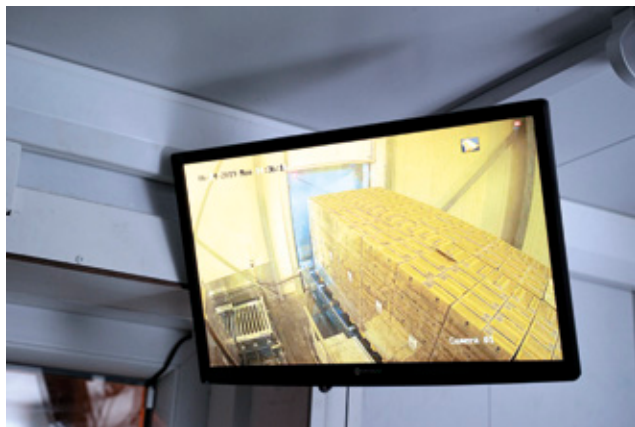

The driver presses a button to start the fully automated conveying of the pallets from the ATL zone to the refrigerated truck



K50 LED lights from Banner Engineering provide important information about the status of the line modules



The system from Asbreuk Service can easily handle the loading of two trucks an hour

present or the conveyor section that is currently in manual operation.

Signal transmitters such as pushbutton actuators at the control consoles require additional inputs and outputs. The Dutch engineers therefore installed three IP20 I/O devices in the cabinets: Turck's FEN20-16DXP multiprotocol modules effectively make standard switching signals bus-capable in a short time. However, the use of the FEN20 modules is not only restricted to the control consoles: Central control is still retained in the automatic truck loading system (ATL), which the pallets reach by means of a hydraulic lift. The area is monitored by a centrally controlled frequency converter and a Siemens PLC. Turck's FEN20 offers additional inputs and outputs in the control cabinet and communicates with the main controller. However, Asbreuk is not excluding the possibility of soon implementing the decentralized operation of an ATL zone.

Promising market growth

Asbreuk Service is now receiving an increasing number of inquiries for similar complete systems. "The market is

growing: there is a demand everywhere for mass conveyance over short distances," says the company owner. Companies in this case would supply their customers with fewer machines but with an increasing number of functions. The specific technology required for a particular service would then be irrelevant. The flexibility and long-term usability of all elements are the priority. A modular conveyor concept optimally meets these requirements. Asbreuk is already thinking about the next steps: "We have so far only been passing on the number of pallets via the truck. The transfer of more data is possible in order to implement 100 percent goods traceability." The initial prototypes for self-driven trailers are also currently a hot topic. It's logical that autonomous transport should once more offer completely new opportunities.

Author | Maarten Rambach is sales specialist at Turck B. V. in the Netherlands

Customer | www.a-service.nl

Webcode | more21952e

Thanks to the separate signal processor, the status of the sensors is always very visible and the sensor unit is optimally protected

QUICK READ

The company Armaturenwerk Hötensleben GmbH (AWH) looked for a solution for measuring the speed on all sizes of its VPureMix magnetic stirrers. Turck developed a magnetic field sensor specially for this task, which could measure the precise speed of the mixing head in the vessel through its stainless steel wall. Thanks to the two Hall probes fitted, the sensor unit also detects the rotation direction of the mixing heads. With just one sensor type AWH is thus able to increase the process safety of all VPureMix stirrers.



Double Agent

A magnetic field sensor with a dual Hall probe detects the speed and rotation direction of the mixing head in the magnetic stirrers of stainless steel components manufacturer Armaturenwerk Hötensleben GmbH

Adam Opel is a company that started out as a manufacturer of sewing machines and bicycles. After its founding in 1889, Nintendo first started out manufacturing playing cards and is now building games consoles. It is not unusual for a company to increase the complexity of its products over the course of its existence.

The Armaturenwerk Hötensleben GmbH, which is headquartered in Hötensleben in the German state of Saxony-Anhalt, has a similar varied history. The milestones of the company, stretching from 1859 to today, reflect all the stages of recent German history. The company first started as a metal foundry and since 1992 it has been manufacturing stainless steel components such as valves, fittings and connections. Cleaning technology came first in 2003 and pigging technology was added later. AWH has also been recently offering its customers magnetic stirrers in the VPureMix series. The magnetic stirrers, which have been designed for optimum process safety and sterility, are particularly used in the pharmaceutical, biotechnology and food industry. This enables users to homogenize or suspend liquid media gently and efficiently, use them for exchanging heat or balancing concentrations.

Speed sensor for magnetic stirrers

"In order to determine mixing capacity, the information we need includes the speed of the mixing head," explains AWH product manager Anja Hauffe. This is



Two Hall probes are integrated in the tiny sensor housing

implemented in the sector using a speed sensor. Especially when different speeds are required within a production batch, speed measurement is needed on the stirrer. This feature is therefore an absolute necessity for most customers.

The mixing head is driven without contact by magnets – through the vessel wall. Measuring the speed through the magnetic field was an obvious approach. "We needed a sensor that can implement this since the alternatives would have been very inconvenient. We wanted a sensor that we could integrate in the stirrer and use for as many variants of the stirrer series as possible," Hauffe explains the requirement more precisely.

Magnetic coupling of the mixing head ensures the integrity of the vessel and the product

Permanent magnets in the drive unit build a magnetic coupling with magnets in the mixing head. This is so strong that the mixing head can be driven through the vessel wall at 490 revolutions per minute. The vessel plate must be welded into the bottom beforehand in



»The fact that we can cover all sizes with just one sensor is really useful. The software for setting the sensors is also really easy to use. A drop-down list enables me to select the relevant stirrer size. All other parameters are applied automatically via the stored data sets. Everything is done in just two to three clicks.«

Anja Hauffe | Armaturenwerk Hötensleben GmbH

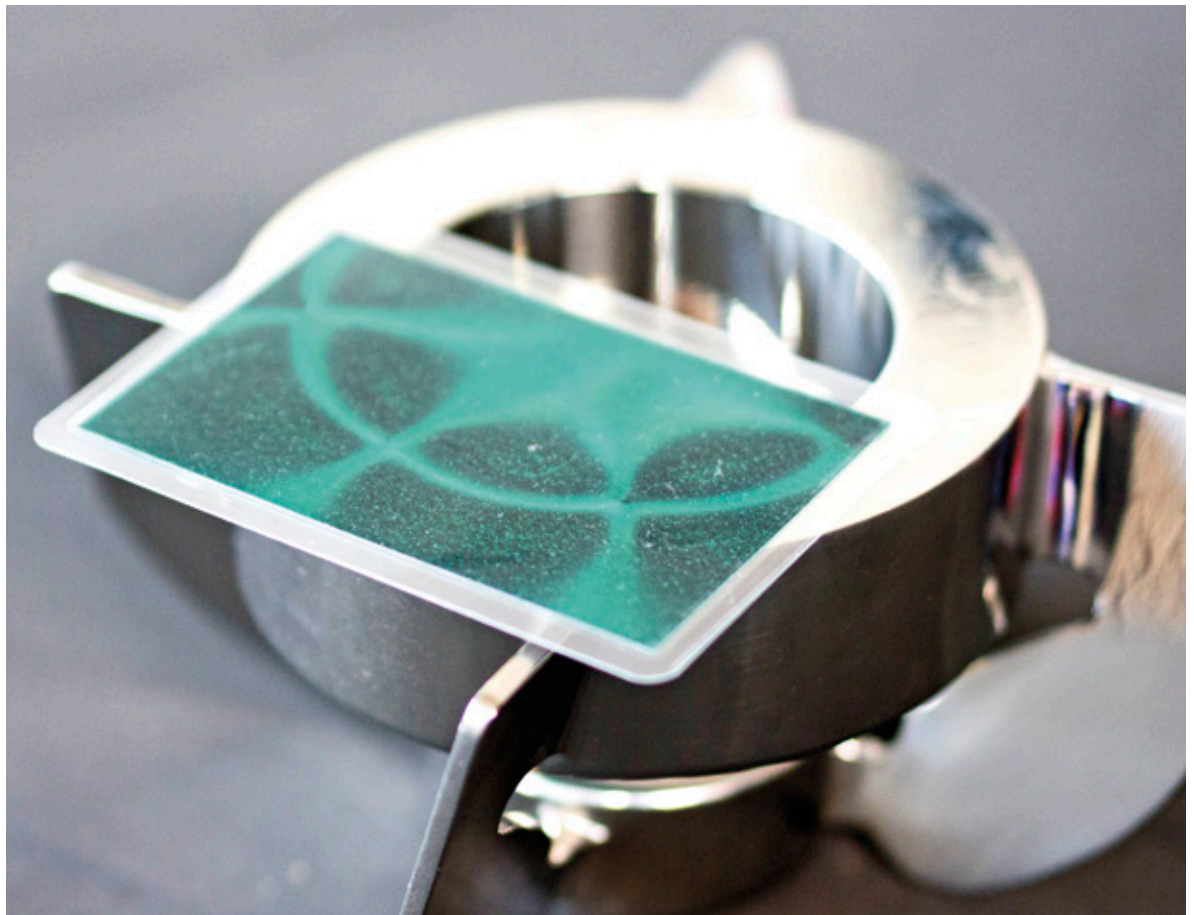

The magnetic field sensor foil makes the field lines of the magnets in the mixing head visible

order to mount the stirrer. Thanks to the magnetic coupling of the drive and the mixing head, the integrity of the vessel is ensured throughout in spite of the mixing process. This therefore excludes the possibility of any sterilization problems and contamination, which can occur with conventional stirrers with a shaft bushing. Only the mixing head and the ceramic bearings are in contact with the medium. They are designed and manufactured so that they can be cleaned easily without any residue.

In the search for sensors that could perform measurements through the vessel wall one off-the-peg solution soon stood out. "We asked several vendors but there was nothing on the market," Hauffe continued. An individual solution therefore had to be developed. AWH therefore contacted Turck, the sensor and automation specialists, from whom they had received good support in the past.

Sensor detects speed and rotation direction

Turck developed a sensor with a separate signal processor. The actual sensor head can therefore be manufactured with a very compact design in order to integrate it at the upper edge of the mixing head support. The sensor head is provided with two active faces, so-called Hall probes, which measure the behavior of the magnetic field by an internal signal offset over time. This therefore makes it possible to not only measure the speed but also the rotation direction. The sensor is assigned parameters for a set rotation

direction. A malfunction is present if it later detects an inverted rotation direction. The LED on the processing unit is then red and the controller also indicates a warning, depending on the user setting.

Process safety through speed and rotation direction monitoring

Not all customers require additional information such as the measurement of speed and rotation direction. The measurement of these two variables increases the safety of the production process in specialist sectors and hazardous plant areas. The pharmaceutical and biotech industry in particular is subject to stringent requirements with regard to the error-free recording, storing and documentation of data for every process step. An incorrect speed can quickly lead to a reduced product yield and significant financial losses. An undetected incorrect rotation direction of the mixing head endangers the magnetic stirrer itself and in explosion hazardous areas could even cause explosions due to electrostatic charge as a result of friction.

Incorrect mounting ruled out

The design of the sensor unit benefits from Turck's experience with robust IP67 products and its know-how in electronics potting. An injection molding was specially created in which the sensor head housing is manufactured from a special plastic. This plastic section is later fully potted with the electronics. The magnetic field sensors must be located permanently and precise-



The new analog modules are particularly flexible for the different types of input signal

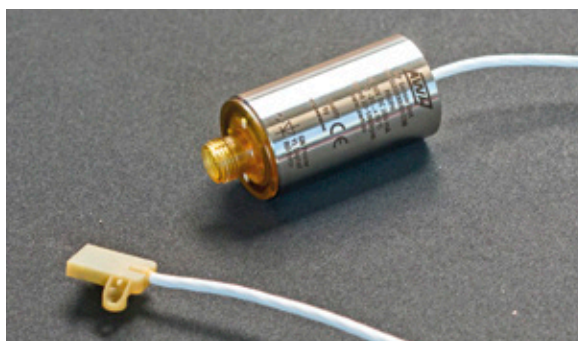

Thanks to the shape and fully potted design, the electronics of the small sensor unit is always correctly seated

ly at a specific angle to the magnetic fields. This is firstly ensured by the potting, and secondly through the special design of the sensor unit, which can only be inserted correctly in the groove of the mixing head support. This design also prevents the sensor from moving. With other manufacturers, the position of the sensors is not fixed and can move through vibration, which then causes incorrect signals and malfunctions.

High visibility optical indicators simplify diagnostics

The separate processing unit is also made from robust stainless steel and is therefore also resistant to aggressive cleaning media. It is provided with diagnostics LEDs that ensure clearly visible indication of the sensor status. For example, if the rotation direction is incorrect, this is indicated to the operator by a red LED. Sensor head, connection lead and processing unit are suitable for continuous operation at ambient temperatures from -20 to +70 degrees Celsius. The sensor and cable can also withstand sterilization (150 degrees Celsius) for

up to an hour. Operation in the explosion hazardous area (ATEX Zone 2) is also possible.

One sensor for all magnetic stirrers

AWH manufactures VPureMix magnetic stirrers in nine sizes, which are fitted with a different number of magnets on the drive and mixing head. If the customer orders a mixer, AWH configures the sensor via IO-Link. The interface for IO-Link is nevertheless kept inaccessible for the end customer. "The fact that we can cover all sizes with just one sensor is really useful. The software for setting the sensors is also really easy to use. A drop-down list enables me to select the relevant stirrer size. All other parameters are applied automatically via the stored data sets. Everything is done in up to three clicks," Hauffe explains. "Even the mounting of the sensor impressed me. The separate sensor unit cannot be damaged, and unlike those of other manufacturers, the processing unit is not made from plastic but stainless steel."

AWH customers impressed

"Customers who ordered a VPureMix magnetic stirrer for the first time were impressed by its quality and operation. Many of them are plant builders and since then prefer our magnetic stirrers. They even now recommend our magnetic stirrers to their customers in the pharmaceutical, biotechnology and food industry," says Anja Hauffe.

Author | Wolfram Stahl is sales specialist at Turck

Customer | www.awh.eu

Webcode | more21953e

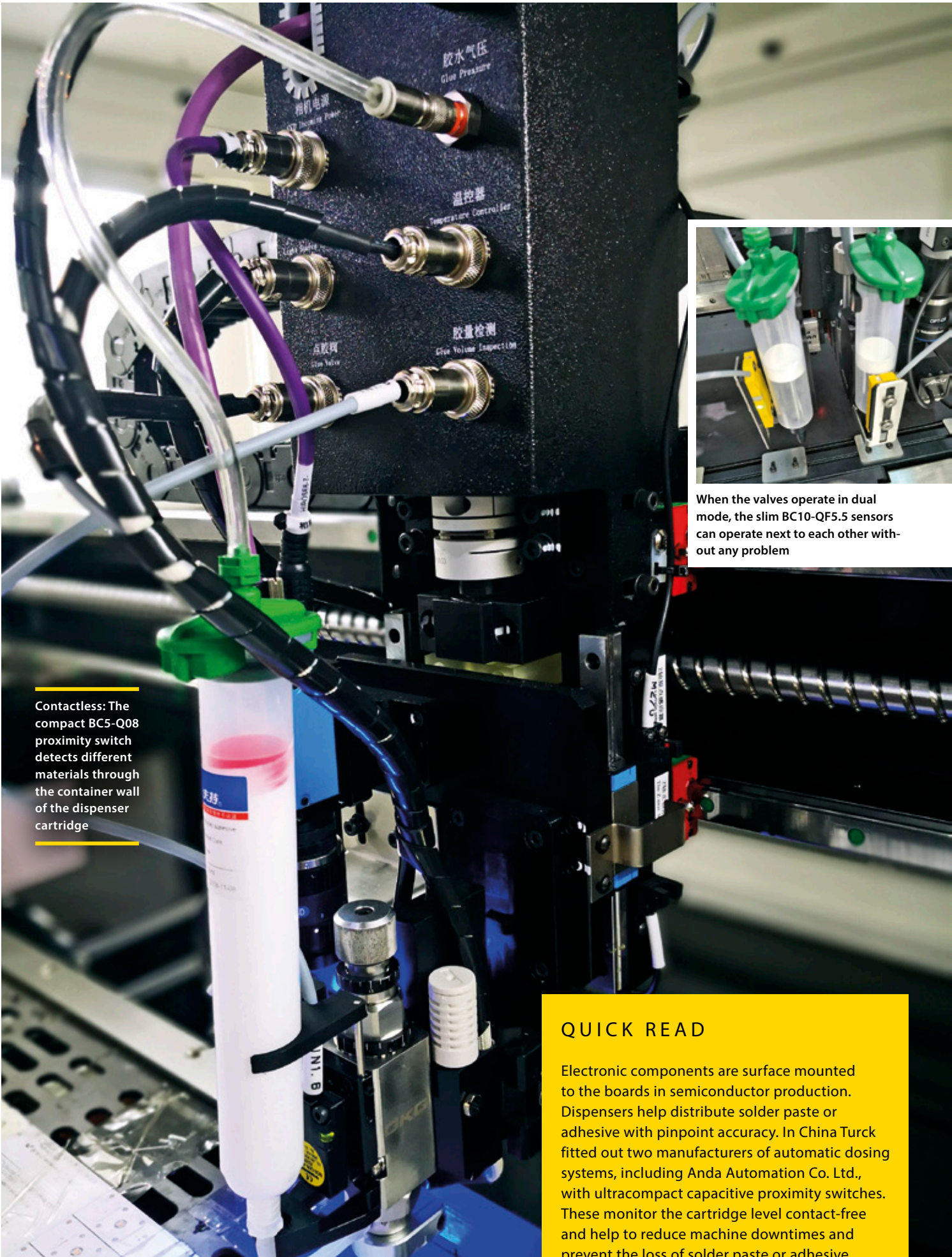

Contactless: The compact BC5-Q08 proximity switch detects different materials through the container wall of the dispenser cartridge

When the valves operate in dual mode, the slim BC10-QF5.5 sensors can operate next to each other without any problem

QUICK READ

Electronic components are surface mounted to the boards in semiconductor production. Dispensers help distribute solder paste or adhesive with pinpoint accuracy. In China Turck fitted out two manufacturers of automatic dosing systems, including Anda Automation Co. Ltd., with ultracompact capacitive proximity switches. These monitor the cartridge level contact-free and help to reduce machine downtimes and prevent the loss of solder paste or adhesive.

Sticking Everything

Dispensers of the Chinese manufacturer Anda Automation distribute soft solder and adhesive at high-speed and require for capacitive sensors level monitoring that are particularly compact – such as Turck's BC10-QF5.5

The “faster, bigger, further” principle is no longer suitable for all aspects of human and technical progress. Best example: Electronics developers who particularly outdo each other to fit devices with ever smaller components. The range functions of many devices is increasing without taking up any more space so that boards have to be fitted with ever more closely arranged assemblies. Whether in medical technology or in your own smartphone, evolution in electronics is leading to miniaturization – something that can only be achieved with suitable manufacturing processes.

SMT assembly: optimum board use

Miniature electronic components are assembled on boards using surface mount technology or SMT for short. Compared to previous methods, this process eliminates the use of complex drill holes for connecting wires, so that components can not only be mounted on the boards in larger numbers and smaller sizes but also on the underside. Manufacturers use fully automated processes like reflow soldering to ensure that passive components, microcontrollers or voltage regulators are securely seated on the board.

In this process soft solder is already applied to the board before assembly and heating. This is distributed, for example, by a dispenser, which is similar to the unit on an inkjet printer. High-speed machines are now capable of placing more than 100,000 dots per hour. Thanks to the additional precision in positioning and dispensing, they are widely used in semiconductor manufacturing and offer a more flexible alternative to stencil printers.

Level monitoring in restricted spaces

It was in these kinds of dispensing systems of Anda Automation Co., Ltd, one of the leading manufacturers in China, that Turck fitted a level monitoring system in a restricted space. In order to prevent any downtime and keep solder losses to a minimum, employees have to be notified when dispenser cartridges reach a critical level. This is made particularly difficult by the elements of the production machine, some of which are tiny. Only extremely small sensors that could also detect substances of different densities could therefore be considered for monitoring the cartridges – and this also had to be possible when subject to severe vibration through a one millimeter thick plastic layer. Above the dispenser needles the Dongguan-based machine builder now uses a Turck capacitive sensor with a rectangular design (BC10-QF5.5), which is only

5.5 millimeters thick and at the same time offers a rated operating distance of 10 millimeters. For parallel operation of the dosing heads, the manufacturer can fit two sensors only a small distance apart. The adaptability of the proximity switches was also impressive: Customers are able to carry out a sensor fine calibration with a potentiometer according to the adhesive or solder in use. “The compact sensor not only enables us to overcome mounting problems but also to rectify faults quickly in the field or respond to changes,” explains Lei Hui Sen, vice president at Anda Automation. “It ultimately helps to prevent any loss of adhesive or solder.”



Lei Hui Sen, vice president at Anda Automation, trusts Turck's compact capacitive sensors

Midget sensor with contactless detection

For another manufacturer of adhesive, dosing and potting machines, the ability to fit the sensor control in an even smaller mounting space was critical. The Chinese company uses Turck's Q08 capacitive sensors in the ultracompact 32 millimeter long design for the contactless level detection. The bright LED indicator of the midget sensor uses different colors to indicate the status of the operating voltage or switching state. The BC5-Q08 also enables users to check the level directly at the machine and refill with liquid, adhesive or solder if necessary.

Author | Xinghuan Fu is product manager fluid sensors at Turck in China
Webcode | more21954e

VERSATILE PRECISION DISPENSERS

The possibilities of using fully automated dosing machines are not only restricted to the dot-based distribution of solder paste. Different dispenser valves and heads can for example apply many different adhesives or potting compound. Some electronic components require special coatings or are provided with more stable fixings on boards with the so-called underfill process with epoxy based polymers. Differences also exist between the contact-based dispensing (for small quantities) and the jet dosing (higher speed).

Heavy Metal

When you need to drill a hole through the Gotthard pass or save the Leaning Tower of Pisa, Rollstar's heavy duty planetary gearboxes are the right tools for the job – fitted with inductive sensors from Turck for the reliable monitoring of speed and switch positions

Torque had already been investigated by Leonardo da Vinci when he toyed – as we know unsuccessfully – with the visionary idea of perpetual motion. Clever sports car fanatics would also rather boast the power of their cars in terms of torque rather than horse power. Torque is a physical parameter that can literally turn the world upside down. For Rollstar AG, the Swiss family-run company based in Egliswil, it is the soul of their business.

Joachim Haslimeier
installs Turck's rugged
sensors on the plane-
tary gearbox

Torques in the most unlikely of areas

While the design engineers at Rollstar build gearboxes and motors with a passion, they nevertheless also operate in a different league to, for example, engine manufacturers in the automotive industry. Their

planetary gearboxes operate at torques of up to 6,500,000 Newton meters and are deployed in heavy duty operation in tunnel drilling rigs, such as in the Gotthard Base Tunnel, in rail, ship and cable car construction, as well as in numerous application fields, often in conjunction with Rollstar hydraulic motors. A showcase example of its wide range of uses is the operation of a hydraulic gear motor on an earth drilling rig, which was deployed in the stabilization of the Leaning Tower of Pisa.

Swiss precision for the world market

Rollstar operates as a niche market supplier, which, in line with Swiss industry tradition, offers quality and precision rather than quantity. The company controls





»We don't just have to be better than our competitors, we also have to be faster.«

Christian Märki | Purchasing manager and member of the extended management board

virtually the entire manufacturing process: All operating steps right up to the heat treatment are completed in-house. "However, we don't just have to be better than our competitors," says Christian Märki, purchasing manager and member of the extended management board, "we also have to be faster."

Modular manufacturing concept for greater flexibility

In order to achieve this objective, production is organized as a modular system. Large supplies of pre-manufactured standard components and highly flexible construction based on modern CAD systems and FE calculation shorten the manufacturing process and guarantee short delivery times. Things also have to move fast at Rollstar if the operation of a gearbox or motor fails: The service team can carry out standard repairs within five working days. Spare parts from the standard range are available worldwide within no more than 72 hours.

Reliable supply chain

Anyone making such promises to their customers must also be able to rely on their suppliers. Rollstar has therefore relied for a long time on Bachofen, Turck's representative in Switzerland, which supplies the machine builder with a range of products including inductive sensors from Turck. These permanently measure the speed, monitoring and switch position in the planetary gearboxes or determine the operating state of the brake. The decision to use Turck originally arose from a customer's request, however the Rollstar purchasing department and engineers have been happy with this ever since. Turck's sensors have been offering impressive service in terms of quality and reliability for more than ten years. As far as their supplier Bachofen is concerned, Rollstar appreciates the company's reliability, the high availability of the products, the open communication and competitive pricing. "One of the most important business principles of Rollstar is to offer the customer an all-round service. This fundamental prerequisite is also guaranteed by Bachofen, who we have regarded as open, trustworthy and flexible partners for years."

Author | Roland Fuchs is automation product manager at Turck's sales partner Bachofen AG in Uster, Switzerland

User | www.rollstar.com

Customer | www.bachofen.ch

Webcode | more21955e



After some fine adjustment, this sensor reliably detects the position of the holding brake



With their increased switching distance the type Bi2-EG08-AP6X-H1341 inductive sensors monitor the switch position of the 2-speed planetary gearbox

QUICK READ

Swiss company Rollstar AG develops and sells, multi-disc brakes, hydraulic motors and planetary gearboxes for extremely high torques up to 6,500,000 Newton meters. At its headquarters in Egliswil, the family-run company runs production on a state-of-the-art high precision machine park and manufactures all its components in-house. For the sensors, the Swiss company relies on Turck's proven and robust inductive sensors – and the services of Turck's Swiss representative Bachofen.

Trade Shows

At numerous national and international trade shows, Turck will introduce you to current product innovations and reliable solutions for factory and process automation. Be our guest and see for yourself.

Date	Trade Show	City, Country
23.01. – 28.01.2020	Imtex – Indian Metal Forming Exhibition	Bangalore, India
10.03. – 12.03.2020	Logimat	Stuttgart, Germany
10.03. – 14.03.2020	Con Expo	Las Vegas, USA
07.03. – 20.03.2020	Amper	Brno, Czech Republic
13.04. – 16.04.2020	Neftegas	Moscow, Russia
20.04. – 24.04.2020	Hannover Messe	Hanover, Germany
21.04. – 24.04.2020	Siams	Moutier, Switzerland
28.04. – 30.04.2020	RFID live	Orlando, USA
29.04. – 30.04.2020	AEC/ISA	Edmonton, Canada
05.05. – 08.05.2020	Industry Days	Budapest, Hungaria
12.05. – 14.05.2020	Fabtech	Mexico City, Mexico
25.05. – 29.05.2020	Elosys	Nitra, Slovakia
26.05. – 28.05.2020	Eliaden	Oslo, Norway
16.06. – 18.06.2020	SME Fabtech	Toronto, Canada
09.09. – 12.09.2020	Automation Expo	Mumbai, India
22.09. – 24.09.2020	Sindex	Bern, Switzerland
29.09. – 02.10.2020	World of Technology & Science (WOTS)	Utrecht, Netherlands
05.10. – 09.10.2020	Agroprod mash	Moskau, Russland
05.10. – 09.10.2020	Transport and Logistics	Brno, Czech Republic
06.10. – 08.10.2020	Scanautomatic	Göteborg, Sweden
07.10. – 08.10.2020	ADM/ATX	Montreal, Canada
09.10. – 07.10.2020	Industrial Transformation	León, Mexico
08.11. – 11.11.2020	Pack Expo	Chicago, USA
18.11. – 20.11.2020	Fabtech	Las Vegas, USA
24.11. – 26.11.2020	SPS – Smart Production Solutions	Nuremberg, Germany
November 2020	Warsaw Industry Week	Warsaw, Poland

The Net

On the Turck website and product database you will find all the relevant information about Turck's products and technologies, systems and industry solutions – from success stories to data sheets right through to the download of CAD data.

www.turck.com



Sites

With over 30 subsidiaries and more than 60 branch offices, Turck is always nearby, anywhere in the world. This guarantees fast contact to your Turck partners and direct support on site.



GERMANY

Headquarters Hans Turck GmbH & Co. KG

Witzlebenstraße 7 | Mülheim an der Ruhr | +49 208 4952-0 | more@turck.com

- **ARGENTINA** | Aumecon S.A.
(+54) (11) 47561251 | ventas@aumecon.com.ar
- **AUSTRALIA** | Turck Australia Pty. Ltd.
(+61) 1300132566 | australia@turck.com
- **AUSTRIA** | Turck GmbH
(+43) (1) 4861587 | austria@turck.com
- **BAHRAIN** | Al Bakali General Trading
(+973) 17 55 11 89 | albakali@albakali.net
- **BELARUS** | DEMS-Energo Ltd.
(+375) (17) 2026800 | turck@demss.by
- **BELGIUM** | Turck Multiprox N. V.
(+32) (53) 766566 | mail@multiprox.be
- **BOLIVIA** | Centralmatic
(+591) 7 7457805 | contacto@centralmatic.net
- **BOSNIA AND HERZEGOVINA** | Tipteh d.o.o.
(+387) 33 452427 | info@tipteh.ba
- **BRAZIL** | Turck do Brasil Ltda.
(+55) (11) 26769600 | brazil@turck.com
- **BRUNEI** | Turck Banner Singapore Pte Ltd
(+65) 65628716 | singapore@turckbanner.com
- **BULGARIA** | Sensomat Ltd.
(+359) (58) 603023 | info@sensomat.info
- **CANADA** | Turck Canada Inc.
(+1) (905) 5137100 | salescanada@turck.com
- **CHILE** | Egaflow S.P.A.
(+56) (2) 2887 0199 | info@egaflow.com
- **CHINA** | Turck (Tianjin) Sensor Co. Ltd.
(+86) (22) 83988188 | china@turck.com
- **COLOMBIA** | Dakora S.A.S.
(+57) (1) 883-7047 | ventas@dakora.com.co
- **COSTA RICA** | Tecnologia Interactiva
(+506) 2572-1102 | info@tecnologiainteractiva.com
- **CROATIA** | Tipteh Zagreb d.o.o.
(+385) (1) 80 53 628 | tipteh@tipteh.hr
- **CYPRUS** | AGF Trading & Engineering Ltd.
(+357) (22) 313900 | agf@agfelect.com
- **CZECH REPUBLIC** | Turck s.r.o.
(+420) 495 518 766 | turck-cz@turck.com
- **DENMARK** | Hans Folsgaard A/S
(+45) 43 208600 | hf@hf.dk
- **DOMINICAN REPUBLIC** | Suplitek SRL
(+809) 682-1573 | aortiz@suplitek.com.do
- **DOMINICAN REPUBLIC** | VZ Controles Industriales, CXA
(+809) 530 5635 | vz.controles@codetel.net.do
- **ECUADOR** | Bracero & Bracero Ingenieros
(+593) (2) 264 1598 | bracero@bracero-ingenieros.com
- **EGYPT** | Electric Technology
(+20) 3 4248224 | electech@electech.com.eg
- **EL SALVADOR** | Elektro S.A. de C.V.
(+503) 2243-8542 | info@elektroelsalvador.com
- **ESTONIA** | Osauhing "System Test"
(+37) (2) 6405423 | systemtest@systemtest.eem
- **FINLAND** | Sarlin Oy Ab
(+358) (10) 5504000 | info@sarlin.com
- **FRANCE** | Turck Banner S.A.S.
(+33) (0)160436070 | info@turckbanner.fr
- **GREAT BRITAIN** | Turck Banner Ltd.
(+44) (1268) 578888 | enquiries@turckbanner.co.uk
- **GREECE** | Athanassios Greg. Manias
(+30) (210) 9349903 | info@manias.gr
- **GUATEMALA** | Prysa
(+502) 2268-2899 | alvaro.monzon@prysaguatemala.com
- **HONDURAS** | Partes Industriales
(+504) 2237-4564 | orlando@part-ind.com
- **HONG KONG** | Hilford Trading Ltd.
(+852) 26245956 | hilford@netnavigator.com
- **HUNGARY** | Turck Hungary Kft.
(+36) (1) 4770740 | hungary@turck.com
- **ICELAND** | KM stál ehf
(+354) 5678939 | kalli@krmstal.is
- **INDIA** | Turck India Automation Pvt. Ltd.
(+91) 7768933005 | india@turck.com
- **INDONESIA** | Turck Banner Singapore Pte. Ltd
(+65) 65628716 | singapore@turckbanner.com
- **IRELAND** | Tektron Electrical
(+353) (21) 4313331 | webenquiry@tektron.ie
- **ISRAEL** | RDT
(+972) 3 645 0780 | info@rdt.co.il
- **ITALY** | Turck Banner S.R.L.
(+39) 2 90364291 | info@turckbanner.it
- **JAPAN** | Turck Japan Corporation
(+81) (3) 52982128 | japan@turck.com
- **JORDAN** | Technology Integration
(+962) 6 464 4571 | info@t.i.jo
- **KENYA** | Westlink Limited
(+254) (53) 2062372 | sales@westlinkitd.co.ke
- **KOREA** | Turck Korea Co. Ltd.
(+82) (2) 69595490 | korea@turck.com
- **KUWAIT** | Warba National Contracting
(+965) 24763981 | sales.wncc@warbagroup.com
- **LATVIA** | Will Sensors
(+37) (1) 67718678 | info@willsensors.lv
- **LEBANON** | Industrial Technologies (ITEC)
(+961) 1 491161 | info@itec.liv.com
- **LITHUANIA** | Hidroteka
(+370) (37) 352195 | hidroteka@hidroteka.lt
- **LUXEMBOURG** | Turck Multiprox N. V.
(+32) (53) 766566 | mail@multiprox.be
- **MALAYSIA** | Turck Banner Malaysia Sdn Bhd
(+60) 12 3730 870 | malaysia@turckbanner.com
- **MEXICO** | Turck Comercial, S. de RL de CV
(+52) 844 4116650 | mexico@turck.com
- **MYANMAR** | RobAioTric Co. Ltd.
(+95) 1 572028 | zawta@robaiotric.com
- **NEW ZEALAND** | CSE-W Arthur Fisher Ltd.
(+64) (9) 2713810 | sales@cse-waf.co.nz
- **NETHERLANDS** | Turck B. V.
(+31) (38) 4227750 | netherlands@turck.com
- **NICARAGUA** | Iprocen S.A.
(+505) 22442214 | ventas@iprocen.com
- **NIGERIA** | Milat Nigeria Ltd.
(+234) (84) 485382 | commercial@milat.net
- **NORTH MACEDONIA** | Tipteh d.o.o. Skopje
(+389) 231 74197 | tipteh@on.net.mk
- **NORWAY** | HF Danyko A/S
(+47) 37090940 | danyko@hf.net
- **OMAN** | Oman Oil Industry Supplies & Services Co. LLC
(+968) 24117600 | info@oois.com
- **PAKISTAN** | Speedy Automation
(+92) (0) 21 34328859 | speedy@cyber.net.pk
- **PAKISTAN** | Route ONE Engineering
(+92) 30051521393 | zunair.k126@gmail.com
- **PANAMA** | Accesorios Industriales, S.A.
(+507) 230 0333 | accindsa@cableonda.net
- **PERU** | NPI Peru S.A.C.
(+51) 1 2454501 | npiperu@npiperu.com
- **PERU** | Segaflo
(+51) 966 850 490 | douglas.santamaria@segaflo.com
- **PHILIPPINES** | Turck Banner Singapore Pte Ltd
(+65) 65628716 | singapore@turckbanner.com
- **POLAND** | Turck sp.z.o.o.
(+48) (77) 4434800 | poland@turck.com
- **PORTUGAL** | Bresimar Automação S.A.
(+351) 234303320 | bresimar@bresimar.pt
- **PUERTO RICO** | Inseco Inc.
(+1) (787) 781-2655 | sales@insecopr.com
- **PUERTO RICO** | Stateside Industrial Solutions
(+1) (305) 301-4052 | sales@statesideindustrial.com
- **QATAR** | Doha Motors & Trading Company WLL
(+974) 44651441 | dohamotor@qatar.net.qa
- **ROMANIA** | Turck Automation Romania SRL
(+40) (21) 2300594 | romania@turck.com
- **RUSSIA** | O.O.O. Turck Rus
(+7) (495) 2342661 | russia@turck.com
- **SAUDI-ARABIA** | Codcon
(+966) 13 38904510 | codconest@gmail.com
- **SAUDI-ARABIA** | Salim M. Al Joab & Partners Co.
(+966) 3 8175065 | salim@aljoabgroup.com
- **SERBIA** | Tipteh d.o.o. Beograd
(+381) (11) 8053 628 | damir.office@tipteh.rs
- **SINGAPORE** | Turck Banner Singapore Pte. Ltd.
(+65) 65628716 | singapore@turckbanner.com
- **SLOVAKIA** | Marpex s.r.o.
(+421) (42) 4440010 | info@marpex.sk
- **SLOVENIA** | Tipteh d.o.o.
(+386) (1) 2005150 | info@tipteh.si
- **SPAIN** | Elion S.A.
(+34) 932982000 | elion@elion.es
- **SOUTH AFRICA** | Turck Banner (Pty) Ltd.
(+27) (11) 4532468 | sales@turckbanner.co.za
- **SWEDEN** | Turck Office Sweden
(+46) 10 4471600 | sweden@turck.com
- **SWITZERLAND** | Bachofen AG
(+41) (44) 9441111 | info@bachofen.ch
- **TAIWAN** | E-Sensors & Automation Int'l Corp.
(+886) 7 7323606 | ez-corp@umail.hinet.net
- **TAIWAN** | Jach Yi International Co. Ltd.
(+886) 2 27312820 | james.yuan@jachyi.com
- **THAILAND** | Turck Banner Trading (Thailand) co., Ltd.
(+66) 2 116 5699 | thailand@turckbanner.com
- **TRINIDAD AND TOBAGO** | Control Technologies Ltd.
(+1) (868) 658 5011 | sales@ctltech.com
- **TURKEY** | Turck Otomasyon Tic. Ltd. Şti.
(+90) (216) 5722177 | turkey@turck.com
- **Ukraine** | SKIF Control Ltd.
(+380) 611 8619 | d.startsev@skifcontrol.com.ua
- **UNITED ARAB EMIRATES** | Experts e&i
(+971) 2 5525101 | sales@experts-ei.com
- **UNITED ARAB EMIRATES** | Indulge Oil and Gas
(+971) 2 4957050 | sales@indulgeglobal.com
- **URUGUAY** | Fidemar S.A.
(+598) 2 402 1717 | info@fidemar.com.uy
- **USA** | Turck Inc.
(+1) (763) 553-7300 | usa@turck.com
- **VENEZUELA** | CADECI S.A.
(+58) (241) 8345667 | cadeci@cantv.net
- **VIETNAM** | Viet Duc Automation co., Ltd.
(+84) 28 3997 6678 | sales@vietducautomation.com.vn

IMPRINT

Publisher

Hans Turck GmbH & Co. KG
Witzlebenstraße 7
45472 Mülheim an der Ruhr, Germany
more@turck.com

Editorial Staff

Klaus Albers (klaus.albers@turck.com)
Simon Dames, Marius Hoff

Contributors to this Issue

Aurel Buda, Klaus Ebinger, Michael Flesch,
Xinghuan Fu, Roland Fuchs, Dr. Bruno Gries,
Dr. Bernhard Grimm, Frank Nolte, Maarten
Rambach, Wolfram Stahl

Art Direction/Graphic Design

Arno Krämer, Britta Fehr

All rights reserved. We reserve the right to make technical changes or correct errors. Reprint and electronic processing permitted with written approval from the publisher.

Your Global Automation Partner

TURCK

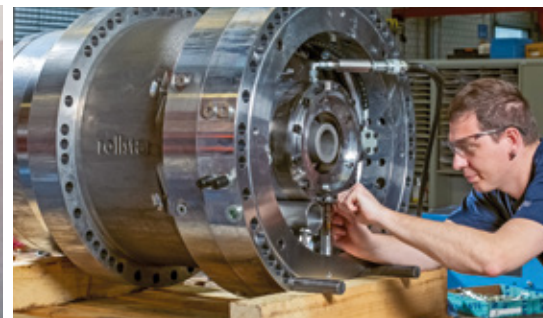
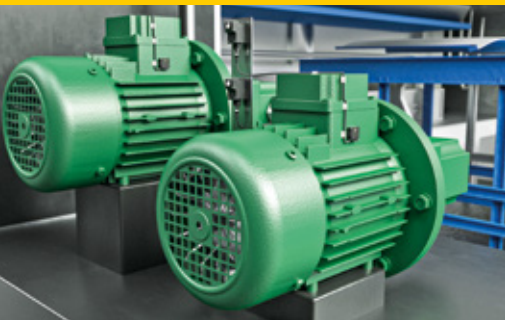

D900901 1911



www.turck.com