

LI150P1-Q17LM1-LIU5X2

Inductive Linear Position Sensor

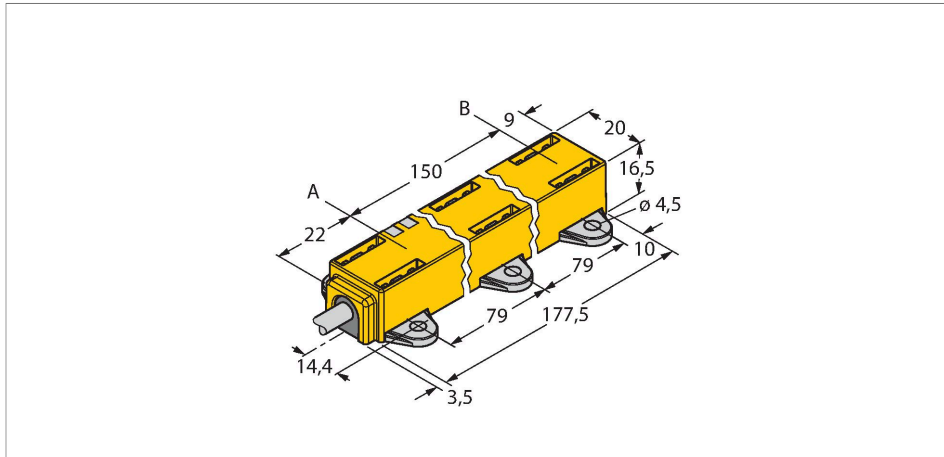

Features

- Rectangular, plastic
- Many mounting possibilities
- Positioning element P1-Li-QR14/Q17L, mounting aids M1.1-Q17L and M1.2-Q17L included in delivery
- LED indicates measuring range
- Immune to electromagnetic interference
- Extremely short blind zones
- Resolution, 12-bit
- 4-wire, 15...30 VDC
- Analog output
- Programmable measuring range
- 0...10 V and 4...20 mA
- Cable connection

Technical data

Type	LI150P1-Q17LM1-LIU5X2
ID	1590731
Measuring principle	Inductive
General data	
Measuring range	150 mm
Resolution	0.04 mm/12 bit
Nominal distance	1.5 mm
Blind zone a	22 mm
Blind zone b	9 mm
Repeat accuracy	≤ 0.03 % of full scale
Linearity deviation	≤ 0.5 % f.s.
Temperature drift	≤ ± 0.01 %/K
Hysteresis	not applied
Electrical data	
Operating voltage	15...30 VDC
Residual ripple	≤ 10 % U_{ss}
Isolation test voltage	≤ 0.5 kV
Short-circuit protection	yes
Wire breakage/Reverse polarity protection	yes / yes (voltage supply)
Output function	4-wire, Analog output
Voltage output	0...10 V
Current output	4...20 mA
Load resistance voltage output	≥ 4.7 kΩ
Load resistance current output	≤ 0.4 kΩ

Wiring diagram

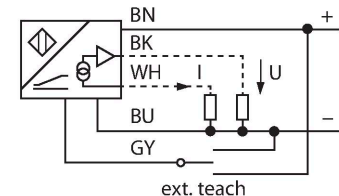

Functional principle

The measuring principle of linear position sensors is based on RLC coupling between the positioning element and the sensor, whereby an output signal is provided proportional to the position of the positioning element. The rugged sensors are wear and tear-free, thanks to the contactless operating principle. They convince through their excellent repeatability, resolution and linearity within a broad temperature range. The innovative technology ensures a high immunity to electromagnetic DC and AC fields.

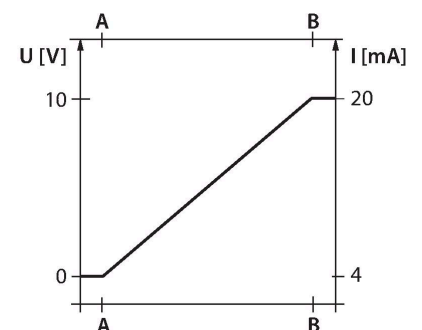

LI150P1-Q17LM1-LIU5X2 | 11/07/2023 15-33 | technical changes reserved

Technical data

Sample rate	700 Hz
Current consumption	< 50 mA
Mechanical data	
Design	Profile, Q17L
Dimensions	181 x 20 x 16.5 mm
Housing material	Plastic, PC-GF10
Electrical connection	Cable
Cable quality	Ø 5.2 mm, Black, LifYY, PVC, 2 m
Core cross-section	5 x 0.25 mm ²
Environmental conditions	
Ambient temperature	-25...+70 °C
Vibration resistance	55 Hz (1 mm)
Shock resistance	30 g (11 ms)
Protection class	IP67
MTTF	138 years acc. to SN 29500 (Ed. 99) 40 °C
Power-on indication	LED, Green
Measuring range display	multifunction LED, green
Included in delivery	positioning element P1-Li-QR14/Q17L, M1.1-Q17L, M1.2-Q17L

Mounting instructions

Mounting instructions/Description

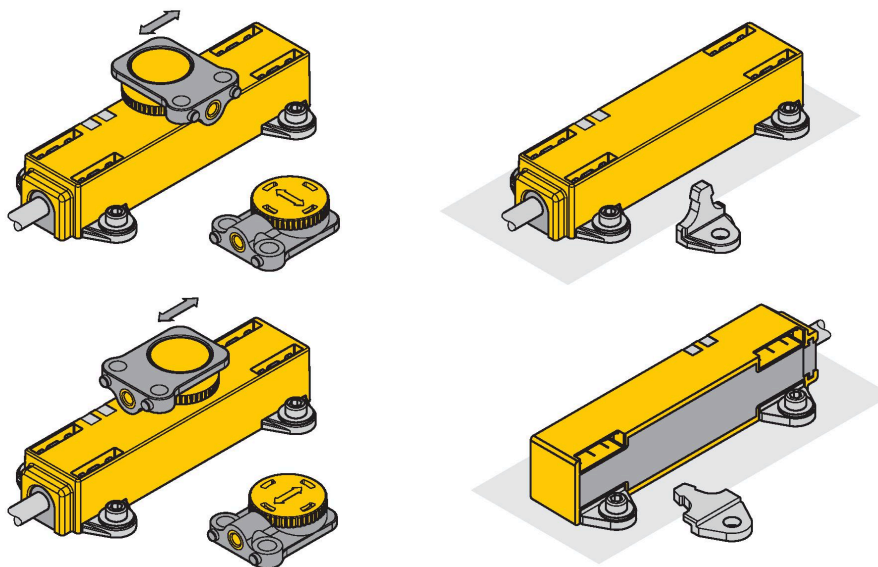

Extensive mounting accessories provide various options for installation. The positioning element can be mounted offset by 90°, thereby providing optimal mounting flexibility. The linear position sensor can also be safely and easily mounted offset by 90° using the two versions of the provided fastening units. The measuring principle of RLC coupling makes the sensor immune to magnetized ferrous chips and other interference fields.

Status display via LED

Green:
Sensor is supplied properly

Measuring range display via LED

Green:
Positioning element is within the measuring range

Green flashing:
Positioning element is within the measuring range, low signal quality (e.g. distance too great)

Off:
Positioning element is outside the detection range

Teaching

The start and end point of the measuring range are set by pressing the button on the teach adapter. Moreover there is the possibility of inverting the course of the output curve.

Bridge pin 5 and pin 1 for 10 s (UB) = factory setting

Bridge pin 5 and pin 3 for 10 s (GND) = factory setting inverted

Bridge pin 5 and pin 3 for 2 s (GND) = sets start value of measuring range

Bridge pin 5 and pin 1 for 2 s (UB) = sets end value of measuring range

Accessories

P1-LI-QR14/Q17L

1590724

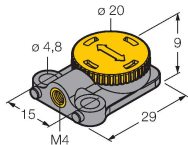

Floating positioning element for linear position sensors LI-QR14 and LI-Q17L; transverse and longitudinal mounting possible; the nominal distance to the sensor is 1.5 mm; pairing with the linear position sensor at a distance of up to 3 mm or a misalignment tolerance of up to 3 mm

M1.1-Q17L

1590749

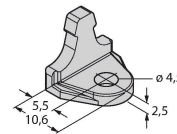

Mounting bracket for linear position sensors LI-Q17L; material: aluminum; 3 pcs. per bag

M1.2-Q17L

1590750

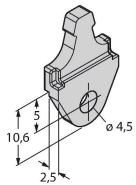

Mounting foot for linear position sensors LI-Q17L; material: aluminum; 3 pcs. per bag

RMT-Q17L

1590755

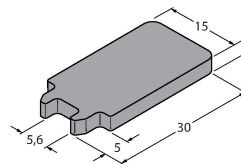

Removal tool for mounting elements for linear position sensors LI-Q17L