

TP-206KK1-CF-H1141-L1000

Temperature Detection – Probe

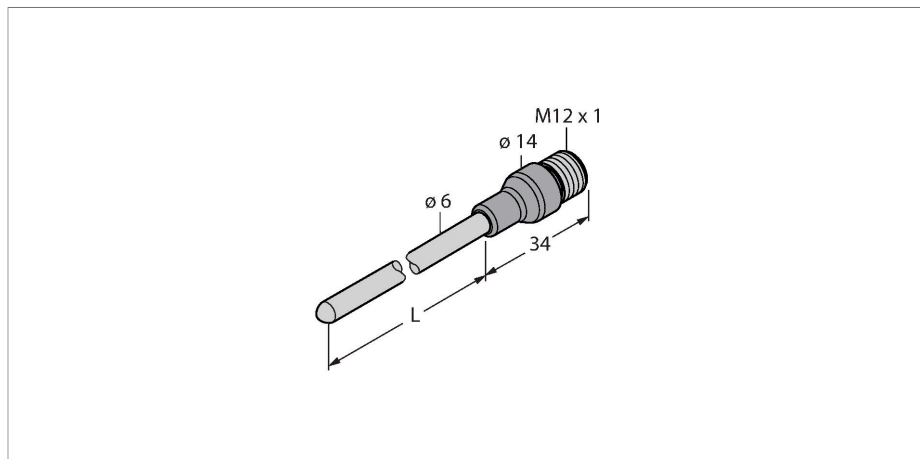

Features

- Thermocouple acc. to DIN EN 60584
- Resistant to vibrations and shocks
- Can be connected to TS720, IM34 or IME-TI
- Max. temperature connector: 120 °C
- 2-wire technology
- Process connection: Compression Fitting
- Bendable probe (min. bending radius: 3x outside diameter)

Wiring diagram

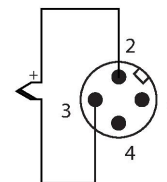

Functional principle

Thermocouples are used for the detection and monitoring of temperatures to optimize and control a process.

Typical applications are in machine and plant construction as well as in the process industry. The core element of the temperature probe is a pair of metallic conductors that are made of different materials and connected at one end. Due to the thermoelectric effect, the thermocouple provides a temperature-dependent voltage.

Technical data

Type	TP-206KK1-CF-H1141-L1000
ID	100034627
Measuring range	-40...1100 °C
	-40...2012 °F
Accuracy	Class 1
Output function	2-wire
Mechanical data	
Design	Temperature probe, TP
Housing material	Metal/plastic, Inconel 600/Nylon
Electrical connection	Connector, M12 × 1
Process connection	For compression fittings, thermowell or direct mounting
Ambient temperature	-40...+85 °C
Storage temperature	-40...+85 °C
Protection class	IP67

Accessories

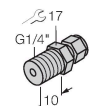
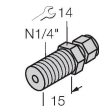
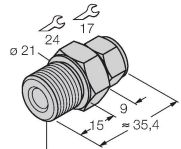
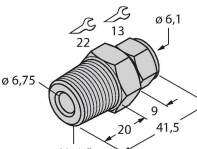
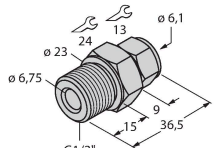
CF-M-6-G1/4-A4	9910483	CF-M-6-N1/4-A4	9910484
<p>Compression fitting for direct mounting of temperature sensors; sensor diameter 6 mm; process connection G1/4" male thread</p>		<p>Compression fitting for direct mounting of temperature sensors; sensor diameter 6 mm; process connection 1/4" NPT male thread</p>	
			
CF-M-6-M18-A4	9910525	CF-M-6-N1/2-A4	9910529
<p>Compression fitting for direct mounting of temperature sensors; sensor diameter 6 mm; process connection M18 x 1 male thread</p>		<p>Compression fitting for direct mounting of temperature sensors; sensor diameter 6 mm; process connection 1/2" NPT male thread</p>	
			
CF-M-6-G1/2-A4	9910530		
<p>Compression fitting for direct mounting of temperature sensors; sensor diameter 6 mm; process connection G1/2" male thread</p>			
			

Wiring accessories

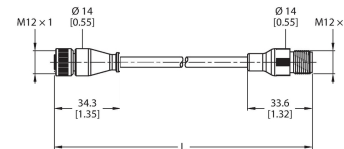
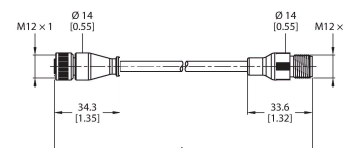
Dimension drawing	Type	ID	
	RK4.217T-2-RS4.217T/TS7198	100033104	Thermocouple cable, type K — extension cable, M12 female connector, straight, 2-pin to M12 male connector, straight, 2-pin; cable length: 2 m, jacket material: TPE, green
	RK4.217T-5-RS4.217T/TS7198	100033105	Thermocouple cable, type K — extension cable, M12 female connector, straight, 2-pin to M12 male connector, straight, 2-pin; cable length: 5 m, jacket material: TPE, green

TP-206KK1-CF-H1141-L1000 | 10/03/2025 21-25 | technical changes reserved

Dimension drawing

Type

ID

RK4.217T-7-RS4.217T/TS7198

100033107

Thermocouple cable, type K — extension cable, M12 female connector, straight, 2-pin to M12 male connector, straight, 2-pin; cable length: 7 m, jacket material: TPE, green

