

Your Global Automation Partner

TURCK

Overview Safety Solutions in IP67



Compact Safety Solutions in IP67

I/O Hybrid Modules for PROFI-safe and CIP Safety

Turck's TBPN and TBIP hybrid safety block I/O modules combine standard and safety inputs/outputs in a single device. This enables the IP65/IP67/IP69K hybrid modules to be adapted flexibly to the actual signal requirements of your machine. The modules can operate with external safety PLCs or also as a standalone remote safety controller.

Easy installation and startup

- Configuration of the safety features via graphical software tool
- Web server simplifies commissioning and diagnostics
- Integrated Ethernet switch enables a linear topology installation

Robust design enables use in harsh industrial environments

- Fully epoxy encapsulated housing for protection of module electronics
- High degrees of protection: IP65/IP67/IP69K
- Extended operating temperature range -40...+70 °C (-40...+85 °C storage)

Benefits

- Simple and rapid implementation in your automation system
- Extensive diagnostic functions
- Possibility to preconfigure the safety functions within the module
- Reduction of I/O devices necessary by combining safety and general purpose I/O in a single device
- Flexible I/O combination supported by configurable input/output points and IO-Link
- Reduced safety wiring complexity due to availability of customized cordset products
- Extremely robust block I/O modules
- Wide application suitability given large temperature range from -40...70 °C
- High degrees of protection to IP65/IP67/IP69K enables direct 'on-machine' mounting
- Removable memory stick for simple device replacement



Hybrid Safety I/O Modules

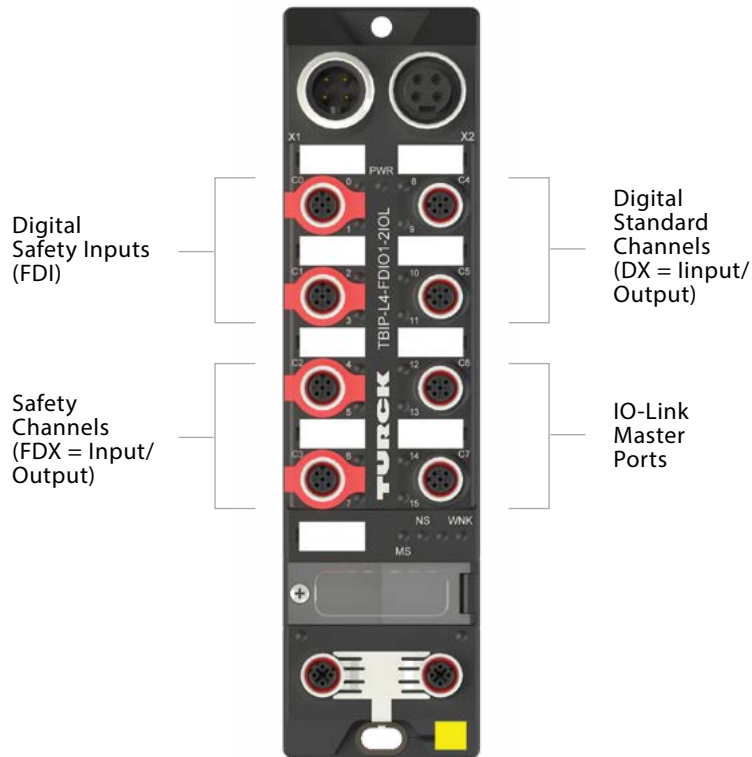

Safety Related Features

- Two redundant safety-related inputs
- Two redundant safety-related universal inputs/outputs
- Safety input ports configurable as potential free (incl. antivalent) or OSSD inputs
- Configurable safety output ports usable as PP or PPM switching.
- Safety output maximum load 2A/output (DC13 with free-wheeling diode)

General Purpose Related Features

- Four configurable digital inputs/outputs
- Configurable output load maximum 2A total; 500mA/output (DC13 with free-wheeling diode)
- Two IO-Link masters
- Maximum load 2A per IO-Link master

Inputs/Outputs

The configurable digital inputs/outputs are suitable for safety disconnections according to SIL3/PL d through the use of an internal safety shutoff. This also applies to the second IO-Link master, internally disconnecting power to the IO-Link port (Class A).

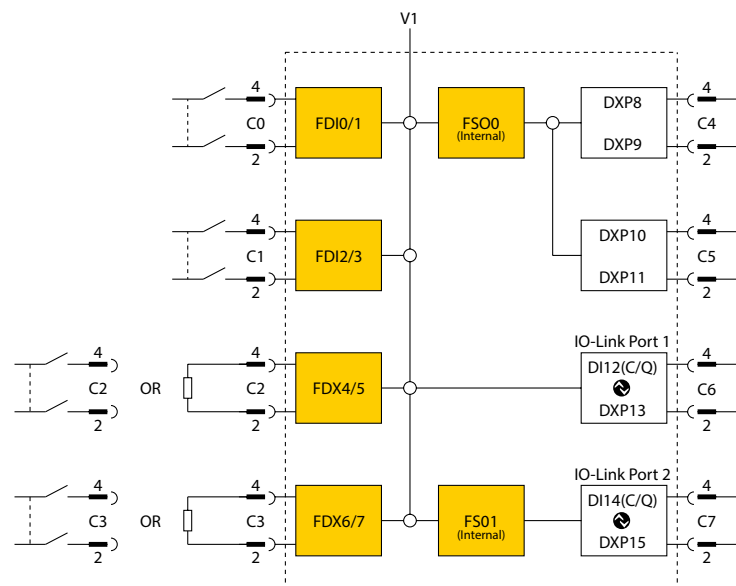

Application Possibilities

Remote I/O for Safety PLC

In this use case the safety logic is performed at the safety capable PLC. The Turck safety modules function as remote I/O for that safety PLC. Turck offers devices capable of communicating as safety remote I/O over PROFI-safe (via PROFINET) and CIP Safety (via Ethernet/IP).

The rugged housing design allows on-machine mounting allows placement near field devices, and the hybrid design of the product makes it ideally suited to simplify installations near areas including both safety and general purpose I/O signals.

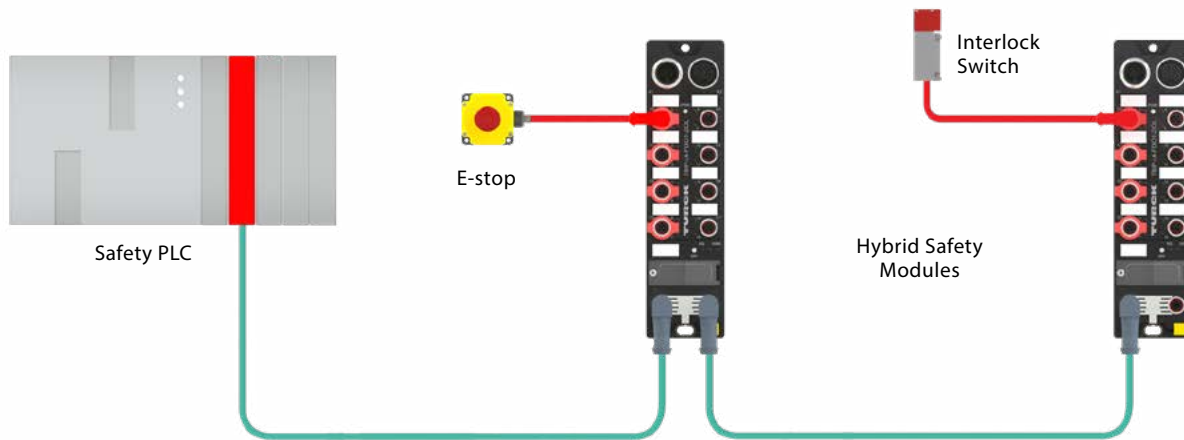

Standalone Safety Control with General Purpose (Non-Safety) PLC

Turck Hybrid Modules also feature the ability to perform local safety logic or for machines with a small number of safety signals; completely eliminating the need for a costly safety PLC. In this case a standard PLC with a PROFINET or Ethernet/IP scanner can still establish a standard communication (non-safety relevant) for access to the general purpose I/O as well as detailed status/diagnostics from the safety configuration.

Local safety control at the Turck safety modules is also beneficial in situations where fast safety response is required. Local logic eliminates the additional latency added by communication to a safety PLC for those priority functions.

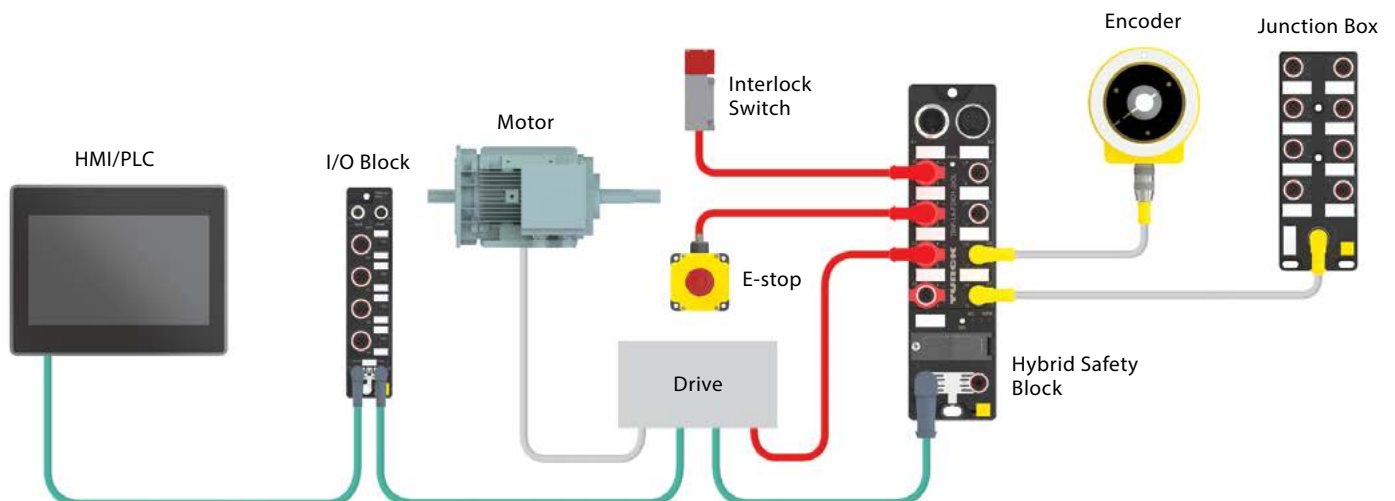

Safe Work Cell

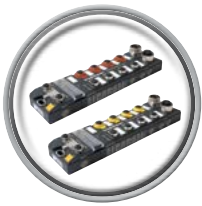
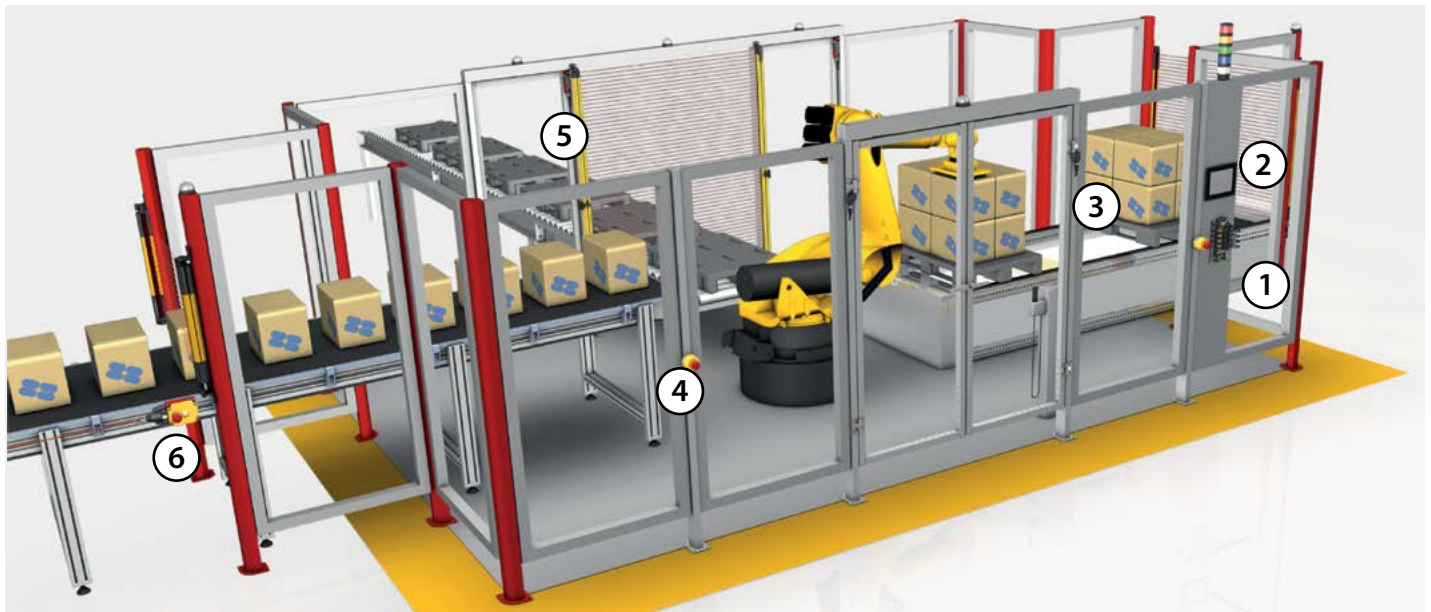

1. Safety I/O Module

Used to collect safety input signals and provide an interface to safety outputs for a centralized functional safety PLC. Turck Hybrid Modules also feature the ability to perform safety logic locally, potentially eliminating the need for a safety PLC.

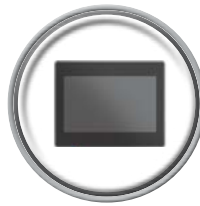

2. Operator Station

Enabling functions are often used for applications in which the presence of persons within the hazardous area of a machine is required. For example during setup or maintenance of robots.



3. Interlock Switches

Guard/Interlock switches provide indication that access doors, gates, or removable panels are properly closed as a condition to allowing a potentially hazardous machine operation to run.



4. E-Stops

Allow a recognizable user interface for manual shutoff of a machine hazard. Illuminated emergency-stop switches, or signal contacts can be used to determine the precise location of an actuated switch when several E-Stop buttons are used in a series.



5. Light Curtains/Scanners

Light curtains and laser scanners detect presence at entry or within a hazardous area. The electrical OSSD outputs of these devices can be integrated in the hybrid module. Custom cabling solutions are available for a variety of connector configurations.



6. Rope Switches

After actuation by manual pull or in the event of a rope break, these devices switch the machine to a safe state. Implemented to provide safety shutoff coverage across an extended hazard, such as along a conveyor system.

Turck Safety Configurator

Configure safety hybrid modules quickly and easily using the Turck Safety Configurator software tool. The software is an intuitive graphical environment used to create a unique configuration for the Turck safety modules based of the specific safety I/O requirements of a given system.

While implementing the Turck safety module as remote I/O for another safety controller; a default configuration is loaded to quickly map the safety relevant I/O to fieldbus signals. In this case the Turck Safety Configurator is primarily used to modify the configurable safety port characteristics and access device diagnostics.

In the case of using a Turck safety module for standalone safety control; the Turck Safety Configurator allows complete programming of the safety logic functions. For this the development software offers a wide range of libraries, application and logical function blocks necessary to support a functional safety system.

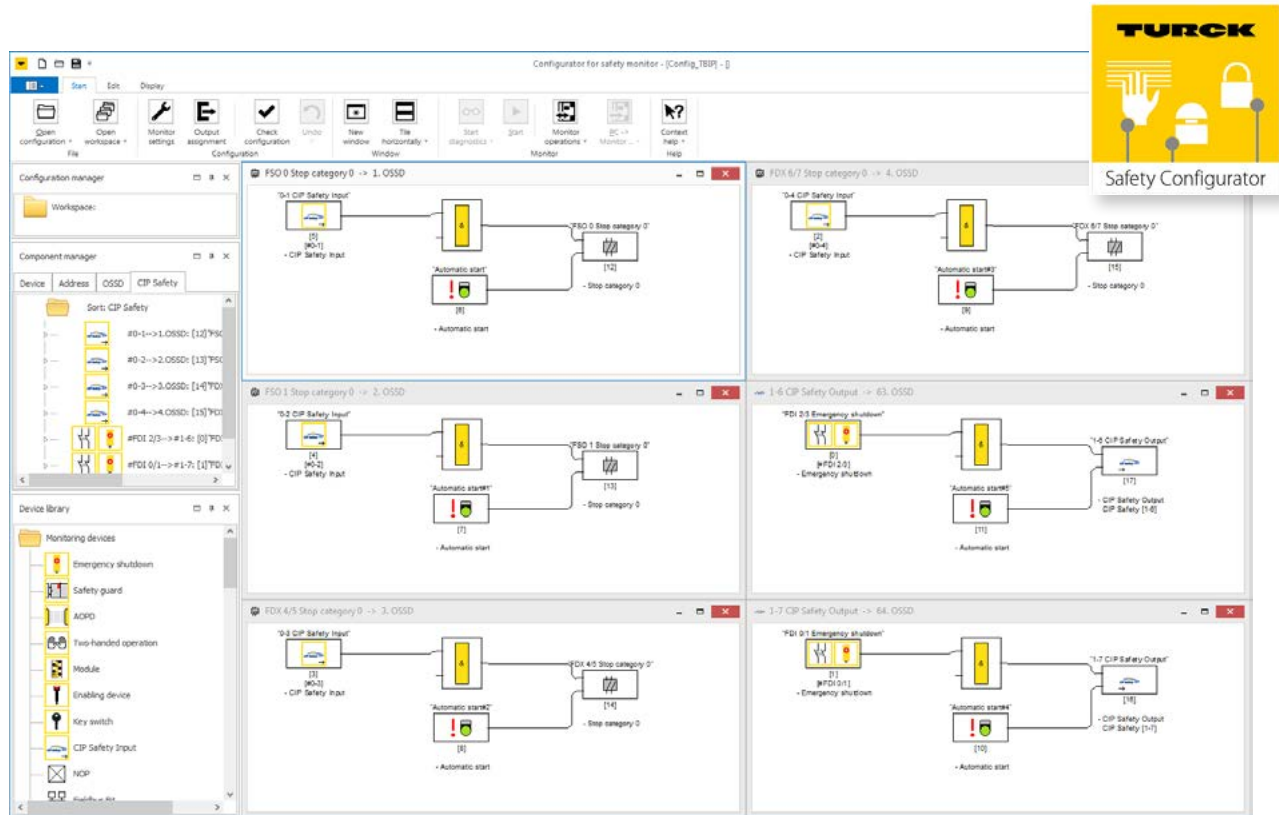

The Turck Safety Configurator also allows an online connection to a safety device to view the active diagnostic status of each safety signal and logical function during machine operation in real time.

Once a Turck safety module has been commissioned with the Turck Safety Configurator, the device and safety configuration can be easily transferred using a removable memory stick, located under a sealed cover on the device. This allows for quick device replacement in the case of a damaged/faulted device.

Related Products and Accessories

Safety Blocks

Part Number	ID Number	Description
TBPN-L1-FDIO1-2IOL	6814053	PROFINET (PROFIsafe) hybrid safety module; 5 pin power
TBIP-L4-FDIO1-2IOL	100000360	Ethernet/IP (CIP Safety) hybrid safety module; 4 pin power
TBIP-L5-FDIO1-2IOL	6814056	Ethernet/IP (CIP Safety) hybrid safety module; 5 pin power

Connectivity

Part Number	ID Number	Description
RK 4.5T-*-RS 4.5T	-	M12x1 connection cordset, PVC jacket, 5-pin, yellow plugs
RK 4.5T-*-RS 4.5T/S1055	-	M12x1 connection cordset, PVC jacket, 5-pin, red plugs
RS 4.5T-*	-	Single-ended male M12x1 connection cordset, PVC jacket, 5-pin, yellow plug
RS 4.5T-*/S1055	-	Single-ended male M12x1 connection cordset, PVC jacket, 5-pin, red plug
VB2-RK8T-*/WS4.5T-*/ WS4.4T-*/S3469	-	Generic input splitter
VB2-RS 4.5T-*/2RKC 8T-*/*/ TYPE 4	-	Splitter for 8-pin M12 light curtain emitter/receiver (ex: Banner EZ-Screen)
B 8151-0/PG9	U6565	M12x1 field wireable female connector, PG9 cable gland (4.8mm cable OD)
BS 8151-0/PG9	U6570	M12x1 field wireable male connector, PG9 cable gland (4.8mm cable OD)
B 8151-0/PG9	U6565	M12x1 field wireable female connector, PG9 cable gland (4.8 mm cable OD)
BS 8151-0/PG9	U6570	M12x1 field wireable male connector, PG9 cable gland (4.8 mm cable OD)

General Purpose IO-Link Hubs

Part Number	ID Number	Description
TBIL-M1-16DIP	6814100	16x discrete inputs
TBIL-M1-8DOP	6814101	8x discrete outputs
TBIL-M1-16DXP	6814102	16x configurable input/output points
RK 4T-*-RS 4T	-	M12x1 cordset for connection safety block and IO-Link field device (up to 20 m length)

* Indicates the length in meters

TURCK



28 subsidiaries and over
60 representations worldwide!

www.turck.com

Printed in USA

©2018 by Turck Inc. All rights reserved. No part of the
publication may be reproduced without written permission.